

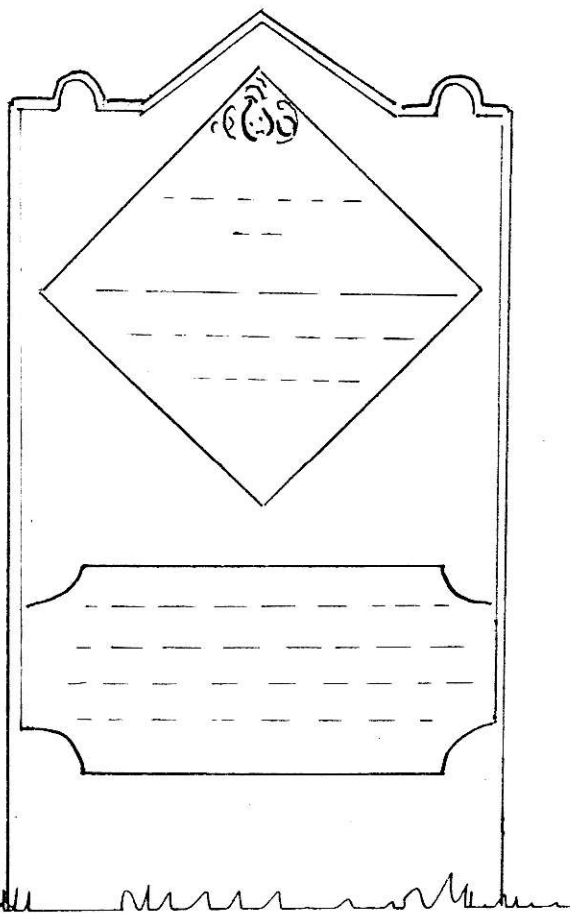

Grave Memorial Recording Form: St. John the Baptist, Westbourne, W. Sussex

1	National Grid Reference	755 073	Date	0	7	0	9	9	9
2	Name of recorder(s)	PETER MERYON & DAPHNE COOPER							
3	Record No. of memorial (plus components i,ii,iii etc.)	N	W	B			1	3	2
4	No. of components or inscribed faces (record on reverse if possible)								
5	Type of memorial: 1 = flat 2 = head 3 = tomb 4 = foot 5 = tablet 6 = other	2							
6	Material and geology	LIMESTONE							
7	Stone mason or undertaker	NONE FOUND							
8	Which surfaces inscribed (facing N, S, E or W)	E							
9	No. of people commemorated	1							
10	Condition of monument: 1=sound 2=displaced 3=leaning 4=collapsed 5=damaged	1							
11	Technique of inscription: 1 = incised 2 = carved in relief 3 = cast in relief 4 = lead letters 5 = painted	1							
12	Condition of inscription 1 = very good 2 = clear 3 = worn but decipherable 4 = partly legible 5 = illegible	2							
13	Dimensions (metric)	height	1	2	2	0			
		width		6	5	0			
		Thickness (or length in case of tombs)			7	0			
14	Date of memorial ? 1810 (1812 or 1814) Register	Not found							
Drawing or Photograph					Inscription				





 the Memory
 of
 WILLIAM PROUDLEY
 who died Augth 29. 181[?]0, 2 or 4
 Aged 42 Years

*Afflictions sore long time I bore
 Physicians skill proved vain
 Till Death did seize & God did please
 To ease me of my Pain*

Grave Memorial Recording Form: St. John the Baptist, Westbourne, W. Sussex

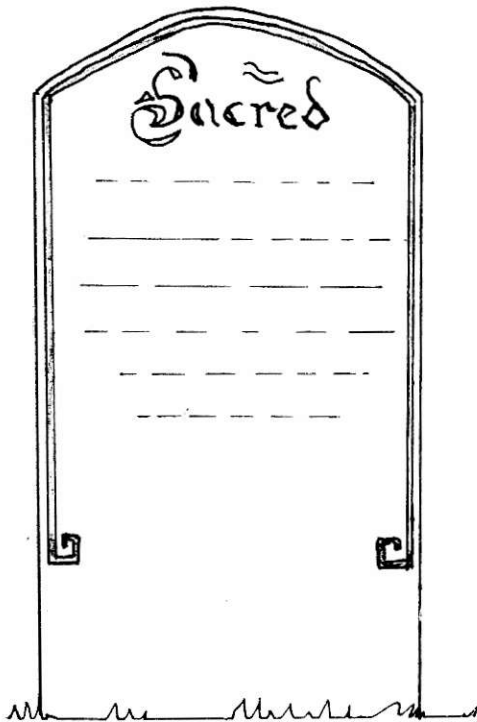
1	National Grid Reference	755 073	Date	1	4	0	9	9	9
2	Name of recorder(s)	BERYL LINDER							
3	Record No. of memorial (plus components i,ii,iii etc.)	NWB		133					
4	No. of components or inscribed faces (record on reverse if possible)	1							
5	Type of memorial: 1 = flat 2 = head 3 = tomb 4 = foot 5 = tablet 6 = other	2							
6	Material and geology	LIMESTONE							
7	Stone mason or undertaker	NONE FOUND							
8	Which surfaces inscribed (facing N, S, E or W)								E
9	No. of people commemorated	1							
10	Condition of monument: 1=sound 2=displaced 3=leaning 4=collapsed 5=damaged								1
11	Technique of inscription: 1 = incised 2 = carved in relief 3 = cast in relief 4 = lead letters 5 = painted								1
12	Condition of inscription 1 = very good 2 = clear 3 = worn but decipherable 4 = partly legible 5 = illegible								2
13	Dimensions (metric)	height	1	2	7	0			
		width		6	6	0			
		Thickness (or length in case of tombs)			7	0			
14	Date of memorial	1854+	Register	Caroline Chase (Westbourne)					
				bu. July 14, 1854, a. 43					
Drawing or Photograph					Inscription				



Sacred
 TO THE MEMORY OF
 CAROLINE . WIFE OF
 RICHARD CHASE
 who departed this Life
 the 10TH of July 1854.
Aged 43 Years

Grave Memorial Recording Form: St. John the Baptist, Westbourne, W. Sussex

1	National Grid Reference	755 073	Date	2	5	0	4	0	0
2	Name of recorder(s)	JOHN LAMPLUGH							
3	Record No. of memorial (plus components i,ii,iii etc.)	N	W	B			1	3	4
4	No. of components or inscribed faces (record on reverse if possible)	3							
5	Type of memorial: 1 = flat 2 = head 3 = tomb 4 = foot 5 = tablet 6 = other	plus body-stone 4 2							
6	Material and geology	Limestone (head & foot stones) Brick (body stone)							
7	Stone mason or undertaker	none found							
8	Which surfaces inscribed (facing N, S, E or W)	(iii) W (i) E							
9	No. of people commemorated	6							
10	Condition of monument: 1=sound 2=displaced 3=leaning 4=collapsed 5=damaged	head 3							
11	Technique of inscription: 1 = incised 2 = carved in relief 3 = cast in relief 4 = lead letters 5 = painted	1							
12	Condition of inscription 1 = very good 2 = clear 3 = worn but decipherable 4 = partly legible 5 = illegible	3							
13	Dimensions (metric)	(ii) bodystone		length 2060 width 780 height 130		(i) head stone		height 130 width 90 thickness (or length in case of tombs) 70	
14	Date of memorial	prob. 1803+		Register Benjamin Turner Gent, a-88 bu28 Jan. 1803 Elizabeth wife of Benjamin Turner bu27 Nov. 1777; // Ann d. of Benjamin Turner b. 11 March 1789 // William Turner, Westbourne, bu. March 4 1854, a.85 // Ann 1770; year missing // Anne 1812 not found					
	Drawing or Photograph	Inscription							

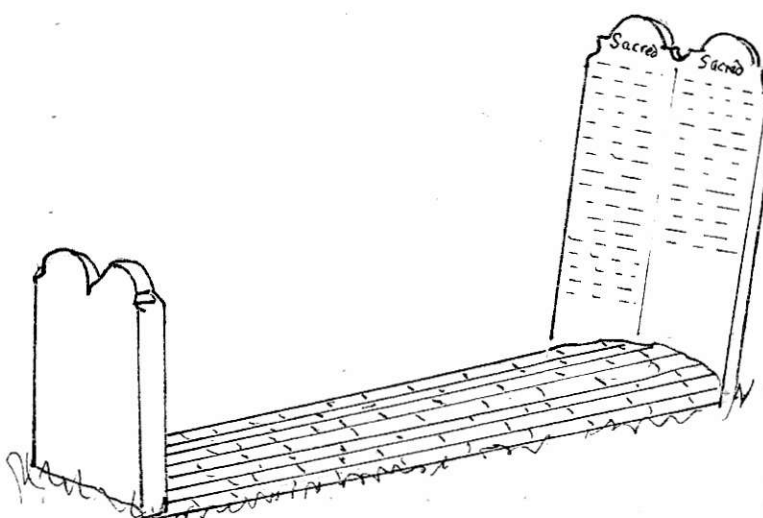

<p>Sacred</p> <p>TO THE MEMORY OF BENJAMIN TURNER of Sindells who died the 22nd of January 1803 Aged 55 Years Also ELIZABETH Wife of the above who died the 21st of November 1777 Aged 44 Years Also Two Daughters of the above ANN who died the 2nd of April 1770 Aged 6 Years ANN who died the 7th of March 1789 Aged 17 Years</p>	<p>Sacred</p> <p>TO THE MEMORY OF WILLIAM TURNER Son of BENJAMIN and ELIZABETH TURNER of Sindells who died the 28th of February 1854 Aged 84 Years Also ANN Wife of the above who died the 17th of July 1812 Aged 46 Years</p>
---	---

NWB 34(iii)

footstone facing W

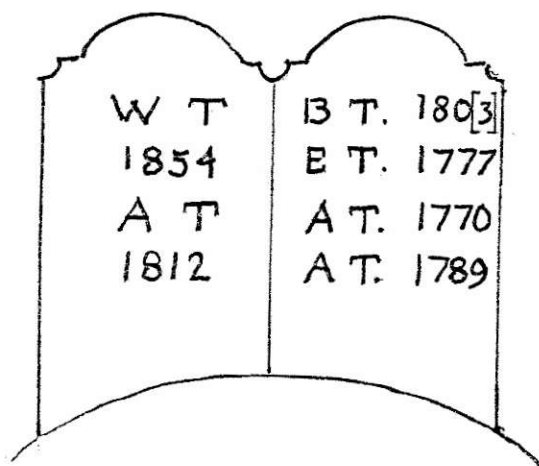

height 62.0
width 60.5 cm
thickness 7.0

Grave Memorial Recording Form: St. John the Baptist, Westbourne, W. Sussex

1	National Grid Reference	755 073	Date	2	8	0	9	9	9
2	Name of recorder(s)	June Marshall							
3	Record No. of memorial (plus components i,ii,iii etc.)	N	W	B			1	3	5
4	No. of components or inscribed faces (record on reverse if possible)								
5	Type of memorial: 1 = flat 2 = head 3 = tomb 4 = foot 5 = tablet 6 = other	2							
6	Material and geology	Limestone							
7	Stone mason or undertaker	Not known							
8	Which surfaces inscribed (facing N, S, E or W)	E							
9	No. of people commemorated	2							
10	Condition of monument: 1=sound 2=displaced 3=leaning 4=collapsed 5=damaged	1							
11	Technique of inscription: 1 = incised 2 = carved in relief 3 = cast in relief 4 = lead letters 5 = painted	1							
12	Condition of inscription 1 = very good 2 = clear 3 = worn but decipherable 4 = partly legible 5 = illegible	4							
13	Dimensions (metric)	above groundheight	6	9	0	width	6	5	0
		Thickness (or length in case of tombs)		8	0				
14	Date of memorial	1707 or 1708	Register bu. Mary d. of George Blatch May 7 th 1707						
		bu. Elizabeth d. Geo. Blatch March 10 th 1724/5	[Poss. 13 each]						
Drawing or Photograph					Inscription				

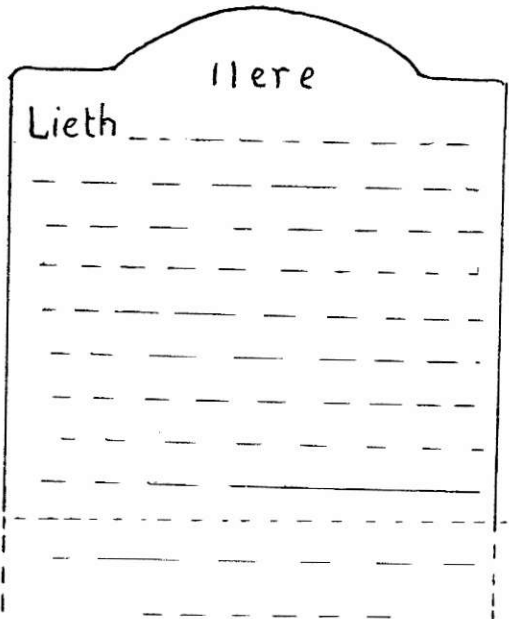

Here
 Lieth y^e Body of Mary
 Blatch Dafter of George &
 Elizabeth Blatch Who Departe
 This Life May y^e 7th 1707
 Aged One year & 6 Months
 & Allso Elizabeth Blatch Daft
 of George & Elizabeth Who
 Departed this Life March y^e 10th
 1724 Aged 30 years When
 And
 [in My Grave
 Laid at Last

same day given for Mary's death & burial

Grave Memorial Recording Form: St. John the Baptist, Westbourne, W. Sussex

1	National Grid Reference	755 073	Date	2	1	0	9	9	9
2	Name of recorder(s)	KEITH LINDER							
3	Record No. of memorial (plus components i,ii,iii etc.)		T	W	B		1	3	6
4	No. of components or inscribed faces (record on reverse if possible)								
5	Type of memorial: 1 = flat 2 = head 3 = tomb 4 = foot 5 = tablet 6 = other								
6	Material and geology	TOP & PLINTH : LIMESTONE SIDES : BRICK							
7	Stone mason or undertaker	NONE FOUND							
8	Which surfaces inscribed (facing N, S, E or W)								
9	No. of people commemorated								
10	Condition of monument: 1=sound 2=displaced 3=leaning 4=collapsed 5=damaged								
11	Technique of inscription: 1 = incised 2 = carved in relief 3 = cast in relief 4 = lead letters 5 = painted								
12	Condition of inscription 1 = very good 2 = clear 3 = worn but decipherable 4 = partly legible 5 = illegible								
13	Dimensions (metric)	height		9	9	0			
		width	1	0	1	0			
		Thickness (or length in case of tombs)	1	9	7	0			
14	Date of memorial	1828 +	Register James Caplin bu.	Feb. 28 1828 a. 48					
		Sarah Caplin b. 14 March 1829, a. 51, of Salisbury			// of Chichester				
Drawing or Photograph					Inscription				

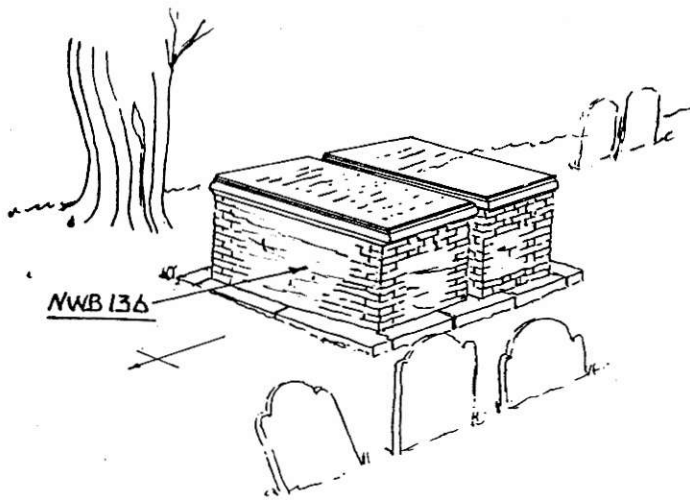

IN MEMORY OF
 JAMES CAPLIN
 LATE OF CHICHESTER SUSSEX
 HE DIED FEB 23 1828
 AGED 48 YEARS

 HERE ALSO ARE DEPOSITED
 THE MORTAL REMAINS OF
 SARAH THE WIFE OF
 JAMES CAPLIN
 AND DAUGHTER OF MARY
 AND NATHANIEL BRUNWIN
 OF LONDON
 SHE DIED MARCH 8th 1829
 AGED 50 YEARS

(Spurling's record no. 23....)

Grave Memorial Recording Form: St. John the Baptist, Westbourne, W. Sussex

1	National Grid Reference	755 073	Date	1	8	1	0	0	1	
2	Name of recorder(s)	KEITH LINDER								
3	Record No. of memorial (plus components I,II,III etc.)		N	W	B			1	3	8
4	No. of components or inscribed faces (record on reverse if possible)									
5	Type of memorial: 1 = flat 2 = head 3 = tomb 4 = foot 5 = tablet 6 = other									
6	Material and geology	STONE: LIMESTONE								
7	Stone mason or undertaker	NONE FOUND								
8	Which surfaces inscribed (facing N, S, E or W)									E
9	No. of people commemorated									
10	Condition of monument: 1=sound 2=displaced 3=leaning 4=collapsed 5=damaged									1
11	Technique of inscription: 1 = incised 2 = carved in relief 3 = cast in relief 4 = lead letters 5 = painted									1
12	Condition of inscription 1 = very good 2 = clear 3 = worn but decipherable 4 = partly legible 5 = illegible									4
13	Dimensions (metric)	height	1	2	8	0				
		width		6	9	5				
		Thickness (or length in case of tombs)			6	5				
14	Date of memorial 1795 +	Register	James s. Samuel Benness bur. 12 May 1782 // John s. Samuel Benness bur. 6 Apr. 1795							
			Sarah d. Samuel Benness bu. 26 Dec 1783							
	Drawing or Photograph		Inscription							

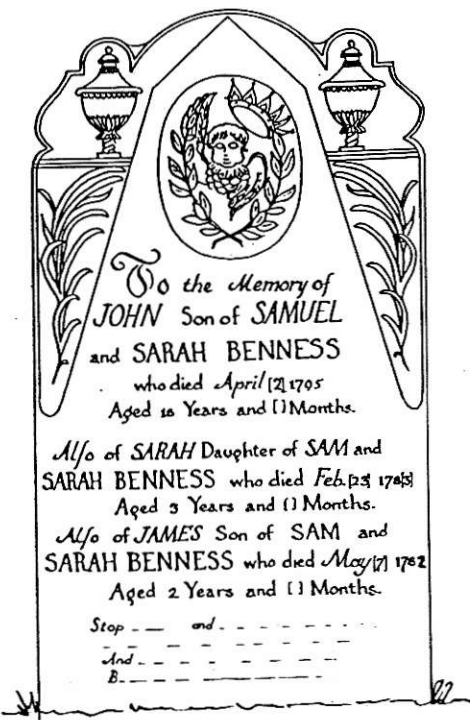

To the Memory of
 JOHN Son of SAMUEL
 and SARAH BENNESS
 who died April [2] 1795
 Aged 18 Years and [] Months.

Also of SARAH, Daughter of SAM and
 SARAH BENNESS who died Feb. [23] 1783
 Aged 3 Years and [] Months.

Also of JAMES Son of SAM and
 SARAH BENNESS who died May [7] 1782
 Aged 2 Years and [] Months.

Stop _____ and _____
 And _____
 B. _____

NOTE THE INCONSISTENCY OF DATE FOR SARAH: THE INSCRIPTION QUOTES FEBRUARY, THE REGISTER DECEMBER

Grave Memorial Recording Form: St. John the Baptist, Westbourne, W. Sussex

1 National Grid Reference	755 073	Date	1	2	1	0	9	9	
2 Name of recorder(s)	KEITH LINDER								
3 Record No. of memorial (plus components i,ii,iii etc.)	N	W	B			1	3	7	
4 No. of components or inscribed faces (record on reverse if possible)									
5 Type of memorial: 1 = flat 2 = head 3 = tomb 4 = foot 5 = tablet 6 = other	3								
6 Material and geology	TOP & PLINTH: LIMESTONE SIDES: BRICK								
7 Stone mason or undertaker	NONE FOUND								
8 Which surfaces inscribed (facing N, S, E or W)									
9 No. of people commemorated	1								
10 Condition of monument: 1=sound 2=displaced 3=leaning 4=collapsed 5=damaged	1								
11 Technique of inscription: 1 = incised 2 = carved in relief 3 = cast in relief 4 = lead letters 5 = painted	1								
12 Condition of inscription 1 = very good 2 = clear 3 = worn but decipherable 4 = partly legible 5 = illegible	4								
13 Dimensions (metric)	height		9	9	0				
	width		1	0	1	0			
	Thickness (or length in case of tombs)		1	9	7	0			
14 Date of memorial	1871 +	Register Anne Caplin d. of Caleb & Sarah Caplin, John Caplin bu. 24 March 1831 a. 61. ? Midhurst // bu. 20 Oct. 1805 Elizabeth not found // see over for register entries							
Drawing or Photograph			Inscription						

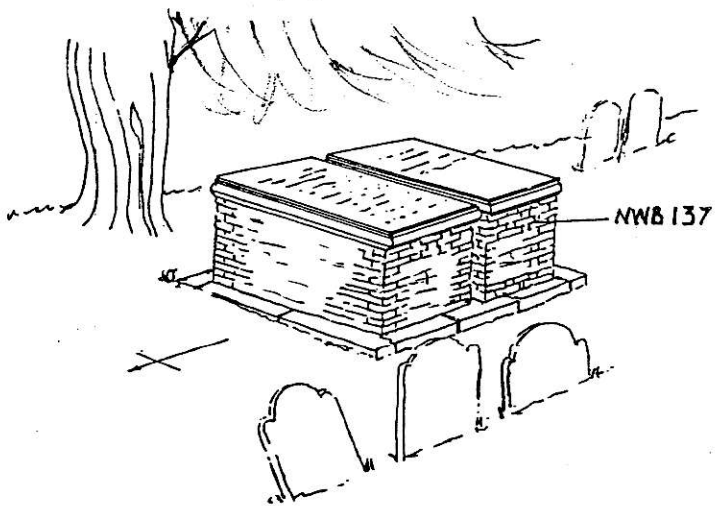

60
the Memory of
ANN CAPLIN

ELIZABETH

Sacred to the Memory of
JOHN CAPLIN who departed this life
the 20th of March 1831 Aged 60 Years
Praises on tombs are vainly spent
A man's good name is his best monument

Sperling recorded "Annie Caplin, d. Octo-ber 17th 1805"; also a Sarah and an Elizabeth, no dates

Grave Memorial Recording Form: St. John the Baptist, Westbourne, W. Sussex

1	National Grid Reference	755 073	Date	0	7	0	9	9	9
2	Name of recorder(s)	KEITH LINDER							
3	Record No. of memorial (plus components i,ii,iii etc.)	N W B			1			3 9	
4	No. of components or inscribed faces (record on reverse if possible)	1							
5	Type of memorial: 1 = flat 2 = head 3 = tomb 4 = foot 5 = tablet 6 = other	2							
6	Material and geology	STONE: LIMESTONE							
7	Stone mason or undertaker	NONE FOUND							
8	Which surfaces inscribed (facing N, S, E or W)	E							
9	No. of people commemorated	1							
10	Condition of monument: 1=sound 2=displaced 3=leaning slightly to the left 4=collapsed 5=damaged	3							
11	Technique of inscription: 1 = incised 2 = carved in relief 3 = cast in relief 4 = lead letters 5 = painted	1							
12	Condition of inscription 1 = very good 2 = clear 3 = worn but decipherable 4 = partly legible 5 = illegible	3							
13	Dimensions (metric)	height	1	1	9	5			
		width	7		5		0		
		Thickness (or length in case of tombs)	7		0				
14	Date of memorial	1780+	Register Sarah w. Samuel Benness bu. Oct. 26, 1780						
Drawing or Photograph					Inscription				

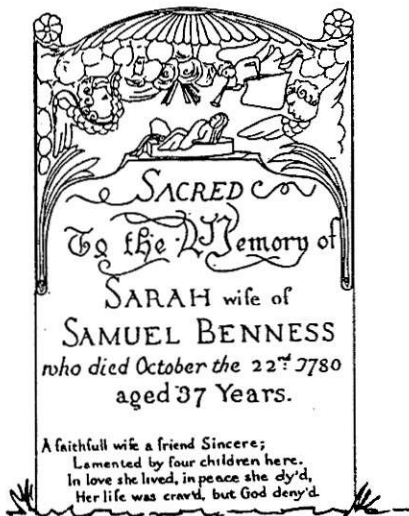

SACRED
 To the Memory of
 SARAH wife of
 SAMUEL BENNESS
 who died October the 22nd 1780
 aged 37 Years.

A faithfull wife a friend Sincere;
 Lamented by four children here.
 In love she lived, in peace she dy'd,
 Her life was crav'd, but God deny'd.

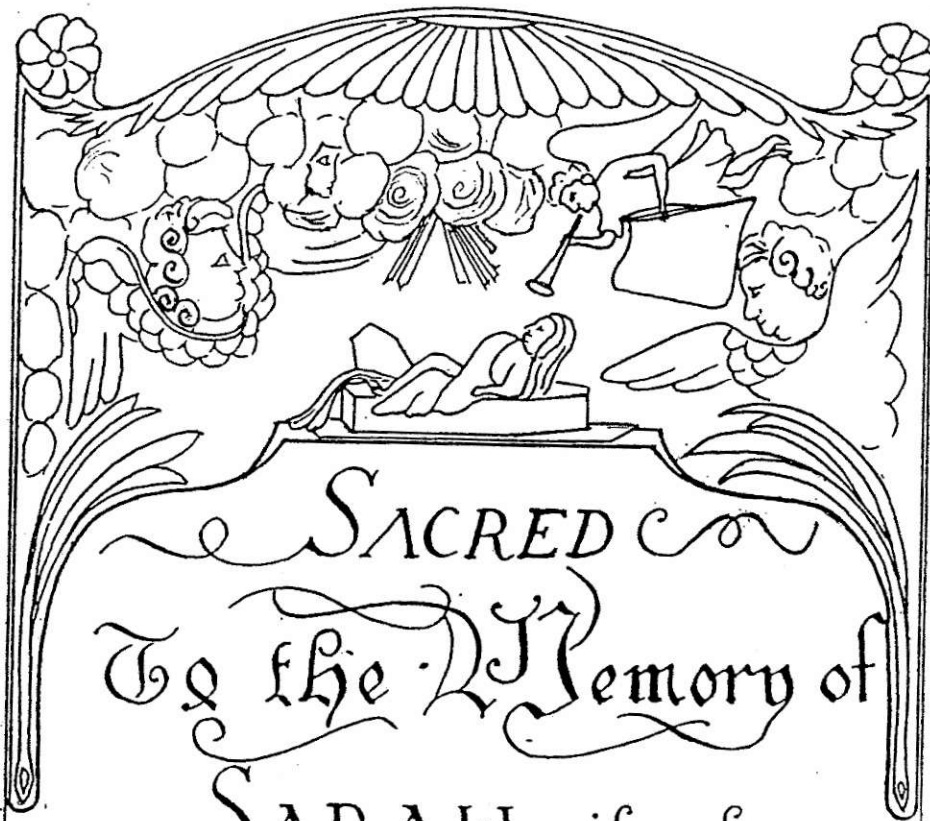

SACRED
 To the Memory of

SARAH wife of
 SAMUEL BENNESS
 who died October the 22nd 1780
 aged 37 Years.

A faithfull wife a friend Sincere;
 Lamented by four children here.
 In love she lived, in peace she dy'd,
 Her life was crav'd, but God deny'd.

Grave Memorial Recording Form: St. John the Baptist, Westbourne, W. Sussex

1	National Grid Reference	755 073	Date	1	4	0	9	9	9
2	Name of recorder(s)	KEITH LINDER							
3	Record No. of memorial (plus components i,ii,iii etc.)	N	W	B			1	4	0
4	No. of components or inscribed faces (record on reverse if possible)								
5	Type of memorial: 1 = flat 2 = head 3 = tomb 4 = foot 5 = tablet 6 = other								
6	Material and geology	STONE: LIMESTONE							
7	Stone mason or undertaker	NONE FOUND							
8	Which surfaces inscribed (facing N, S, E or W)	E							
9	No. of people commemorated								
10	Condition of monument: 1=sound 2=displaced 3=leaning slightly 4=collapsed 5=damaged	1							
11	Technique of inscription: 1 = incised 2 = carved in relief 3 = cast in relief 4 = lead letters 5 = painted	1							
12	Condition of inscription 1 = very good 2 = clear 3 = worn but decipherable 4 = partly legible 5 = illegible	4							
13	Dimensions (metric)	height	1	1	7	0			
		width		7	6	5			
		Thickness (or length in case of tombs)			7	0			
14	Date of memorial 1816 +	Register Samuel Benness Snr. of Portswood City of Southampton bu. 31 Jan. 1816 aged 79 (? Portswood)							
Drawing or Photograph					Inscription				

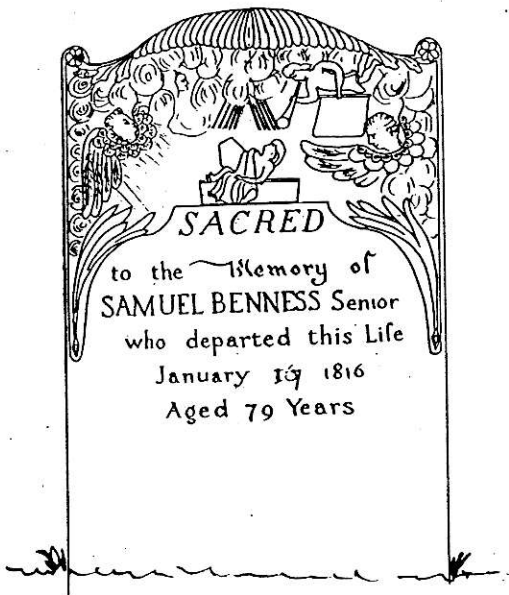

SACRED
to the Memory of
SAMUEL BENNESS Senior
who departed this Life
January 17 1816
Aged 79 Years

A poorly executed copy of no. 139, the memorial to Benness's wife who had died 36 years earlier.

long gap between dates of death + burial is unusual

Grave Memorial Recording Form: St. John the Baptist, Westbourne, W. Sussex

1	National Grid Reference	155 073	Date	0	5	1	0	9	9
2	Name of recorder(s)	June Marshall							
3	Record No. of memorial (plus components i,ii,iii etc.)	N	W	B			1	4	1
4	No. of components or inscribed faces (record on reverse if possible)								
5	Type of memorial: 1 = flat 2 = head 3 = tomb 4 = foot 5 = tablet 6 = other								
6	Material and geology	Limestone							
7	Stone mason or undertaker	Not known							
8	Which surfaces inscribed (facing N, S, E or W)	E							
9	No. of people commemorated	1							
10	Condition of monument: 1=sound 2=displaced 3=leaning 4=collapsed 5=damaged	3							
11	Technique of inscription: 1 = incised 2 = carved in relief 3 = cast in relief 4 = lead letters 5 = painted	1							
12	Condition of inscription 1 = very good 2 = clear 3 = worn but decipherable 4 = partly legible 5 = illegible	2							
13	Dimensions (metric)	height	7	9	0	width	6	3	5
		Thickness (or length in case of tombs)		9	0				
14	Date of memorial	1770+	Register	Richard Oakshatt bu. 21 Oct. 1770 (BT)					
Drawing or Photograph					Inscription				

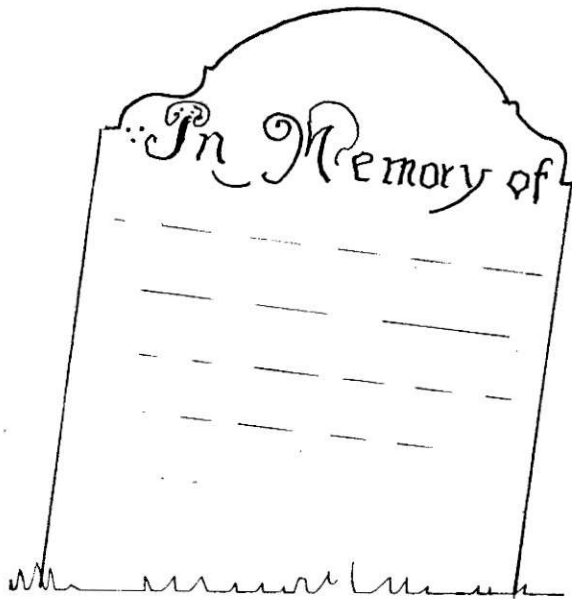

In Memory of
 Richard Oakshatt
 who Departed this Life
 October the 21st 1770
 Aged 72 Years

Grave Memorial Recording Form: St. John the Baptist, Westbourne, W. Sussex

1	National Grid Reference	755 073	Date	0	5	1	0	9	9
2	Name of recorder(s)	DAPHNE MERYON							
3	Record No. of memorial (plus components i,ii,iii etc.)	N	W	B			1	4	2
4	No. of components or inscribed faces (record on reverse if possible)								
5	Type of memorial: 1 = flat 2 = head 3 = tomb 4 = foot 5 = tablet 6 = other	2							
6	Material and geology	STONE: LIMESTONE							
7	Stone mason or undertaker	none found							
8	Which surfaces inscribed (facing N, S, E or W)	E							
9	No. of people commemorated	1							
10	Condition of monument: 1=sound 2=displaced 3=leaning 4=collapsed 5=damaged	1							
11	Technique of inscription: 1 = incised 2 = carved in relief 3 = cast in relief 4 = lead letters 5 = painted	1							
12	Condition of inscription 1 = very good 2 = clear 3 = worn but decipherable 4 = partly legible 5 = illegible	3							
13	Dimensions (metric)	height	8	5	0	width	6	5	5
		Thickness (or length in case of tombs)		8	0				
14	Date of memorial	1766+	Register bu. Mary w. of Rich. Oakshatt 17 Mar. 1766						
Drawing or Photograph					Inscription				

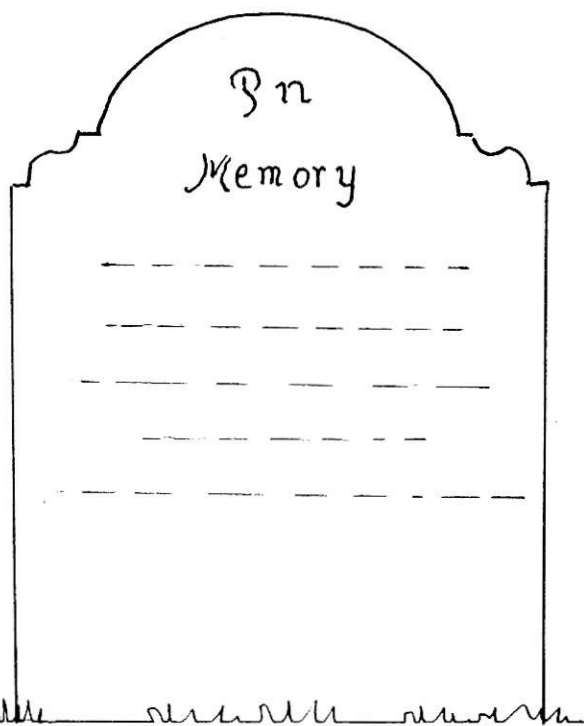



In
Memory
of Mary Wife of
Richard Oakshatt
who Departed this Life
March the 15th 1766
In the 73rd Year of Her Age

(Sperling's record no. *not recorded*)

Grave Memorial Recording Form: St. John the Baptist, Westbourne, W. Sussex

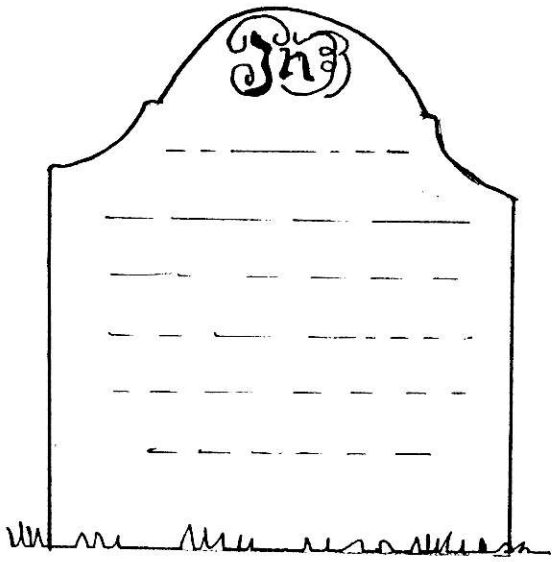
1	National Grid Reference	755 073	Date	0	2	0	9	9	9
2	Name of recorder(s)	June Marshall							
3	Record No. of memorial (plus components i,ii,iii etc.)	N	W	B			1	4	3
4	No. of components or inscribed faces (record on reverse if possible)								
5	Type of memorial: 1 = flat 2 = head 3 = tomb 4 = foot 5 = tablet 6 = other								
6	Material and geology	Limestone: Portland/Purbeck type							
7	Stone mason or undertaker	Not known							
8	Which surfaces inscribed (facing N, S, E or W)								
9	No. of people commemorated								
10	Condition of monument: 1=sound 2=displaced 3=leaning 4=collapsed 5=damaged								
11	Technique of inscription: 1 = incised 2 = carved in relief 3 = cast in relief 4 = lead letters 5 = painted								
12	Condition of inscription 1 = very good 2 = clear 3 = worn but decipherable 4 = partly legible 5 = illegible								
13	Dimensions (metric)	height	7	2	0				
		width	6	0	0				
		Thickness (or length in case of tombs)		8	0				
14	Date of memorial	1765+	Registered to:	Frances Brackstone, Spinster, Dec. 15. 1765					
Drawing or Photograph		Inscription							





 In Memory of
 Frances Brackstone
 who Departed this Life
 December the 9th 1765
 Aged 75 years

(Sperling's record no. not found)

Grave Memorial Recording Form: St. John the Baptist, Westbourne, W. Sussex

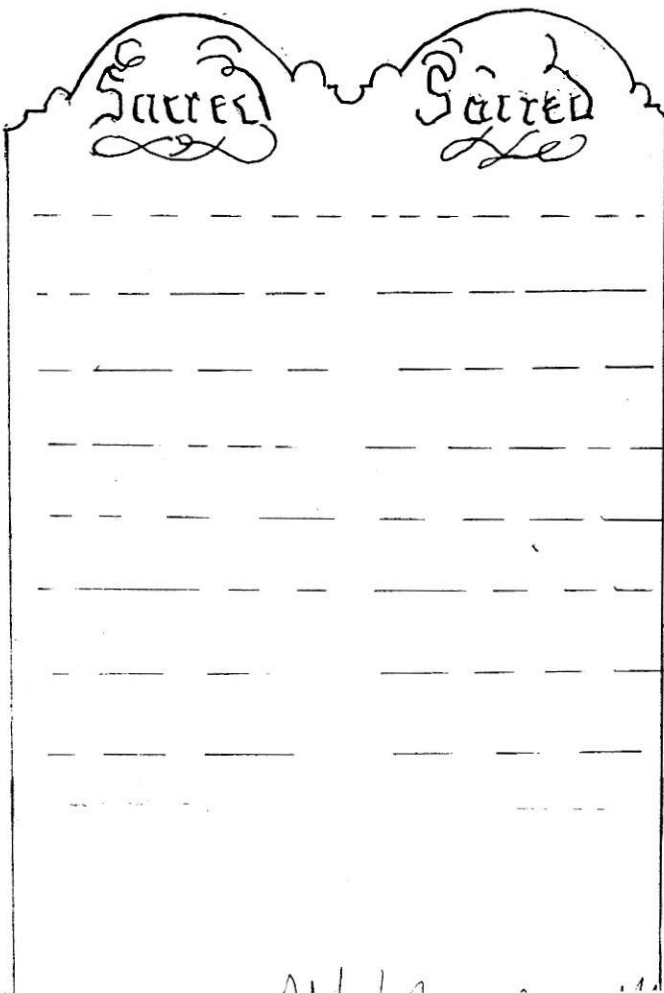
1	National Grid Reference	755 073	Date	1	2	1	0	9	9	
2	Name of recorder(s)	PETER MERYON								
3	Record No. of memorial (plus components i,ii,iii etc.)		N	W	B			1	4	4
4	No. of components or inscribed faces (record on reverse if possible)									1
5	Type of memorial: 1 = flat 2 = head 3 = tomb 4 = foot 5 = tablet 6 = other									2
6	Material and geology	STONE : Limestone								
7	Stone mason or undertaker	none found								
8	Which surfaces inscribed (facing N, S, E or W)									E
9	No. of people commemorated									3
10	Condition of monument: 1=sound 2=displaced 3=leaning 4=collapsed 5=damaged									1
11	Technique of inscription: 1 = Incised 2 = carved in relief 3 = cast in relief 4 = lead letters 5 = painted									1
12	Condition of inscription 1 = very good 2 = clear 3 = worn but decipherable 4 = partly legible 5 = illegible									2
13	Dimensions (metric)	height	1	3	5	0				
		width		8	5	0				
		Thickness (or length in case of tombs)			7	0				
14	Date of memorial	1831 +	Register	James Winham Printhead bu. 5 Sept.						
		Rebecca Winham, Printhead,	bu. 22 Jan. 1834 a. 82 //	1831 aged 82						
				the second James not found						
	Drawing or Photograph									
	Inscription									



Sacred Sacred

to the Memory of to the Memory of

JAMES WINHAM REBECCA WINHAM

who departed this life who departed this life

the 31st August. 1831 the 19th January 1834

Aged 82 Years. Aged 82 Years.

Also to the memory of

JAMES WINHAM Son of the above

who Died the 10th of June 1834 Aged 39 Years

Grave Memorial Recording Form: St. John the Baptist, Westbourne, W. Sussex

1	National Grid Reference	755 073	Date	1	2	1	0	9	9
2	Name of recorder(s)	VERONICA JAY							
3	Record No. of memorial (plus components i,ii,iii etc.)	N	W	B			1	4	5
4	No. of components or inscribed faces (record on reverse if possible)								
5	Type of memorial: 1 = flat 2 = head 3 = tomb 4 = foot 5 = tablet 6 = other								
6	Material and geology	LIMESTONE							
7	Stone mason or undertaker	NONE FOUND							
8	Which surfaces inscribed (facing N, S, E or W)	E							
9	No. of people commemorated	1							
10	Condition of monument: 1=sound 2=displaced 3=leaning 4=collapsed 5=damaged	1							
11	Technique of inscription: 1 = incised 2 = carved in relief 3 = cast in relief 4 = lead letters 5 = painted	1							
12	Condition of inscription 1 = very good 2 = clear 3 = worn but decipherable 4 = partly legible 5 = illegible	3							
13	Dimensions (metric)	height	1	3	8	0			
		width		7	4	0			
		Thickness (or length in case of tombs)			7	0			
14	Date of memorial	1791+	Register Hannah Watts bu.18 Nov.1791						
Drawing or Photograph		Inscription							

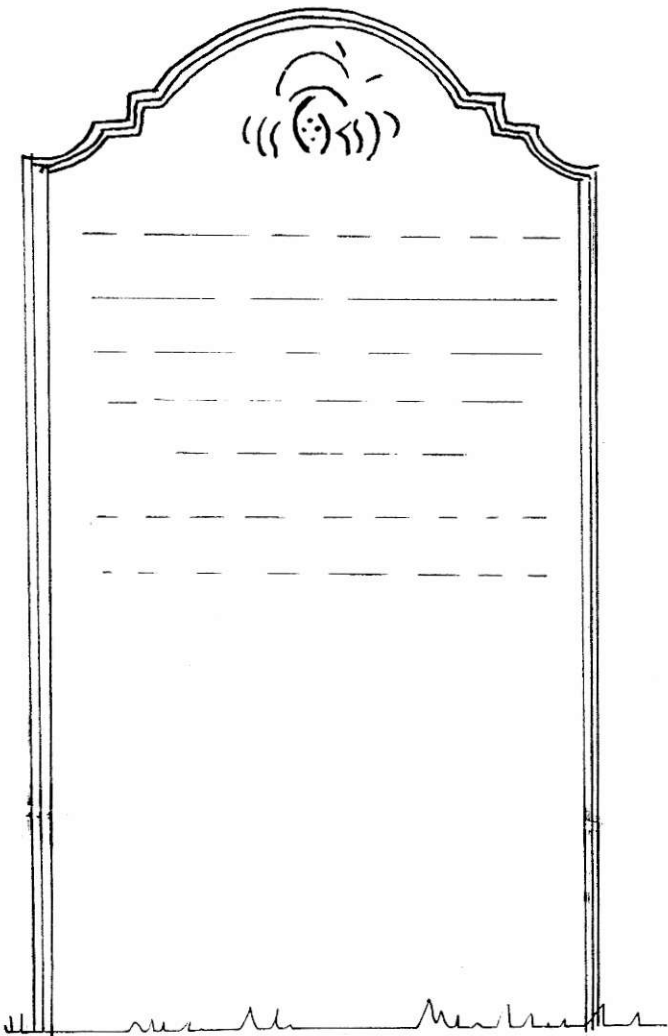

 the Memory of
HANNAH WATTS
 who departed this Life
 November 12th 1791
 Aged 43 Years
 After a tedious illness which she bore
 With patience and with resignation.

*Age 43 or 45 or 42 (Sperling 45)

Grave Memorial Recording Form: St. John the Baptist, Westbourne, W. Sussex

1	National Grid Reference 755 073	Date	3	1	0	8	9	9	
2	Name of recorder(s) KEITH LINDBER								
3	Record No. of memorial (plus components i,ii,iii etc.)		N	W	B		1	4	6
4	No. of components or inscribed faces (record on reverse if possible)								
5	Type of memorial: 1 = flat 2 = head 3 = tomb 4 = foot 5 = tablet 6 = other 2								
6	Material and geology STONE: LIMESTONE								
7	Stone mason or undertaker NONE FOUND								
8	Which surfaces inscribed (facing N, S, E or W)							E	
9	No. of people commemorated							1	
10	Condition of monument: 1=sound 2=displaced 3=leaning slightly to the right 4=collapsed 5=damaged							3	
11	Technique of inscription: 1 = incised 2 = carved in relief 3 = cast in relief 4 = lead letters 5 = painted							1	
12	Condition of inscription 1 = very good 2 = clear 3 = worn but decipherable 4 = partly legible 5 = illegible							2	
13	Dimensions (metric)		height		9	3	0		
			width		6	8	0		
			Thickness (or length in case of tombs)		7	5			
14	Date of memorial 1762 +		Register bu: Mary Farndell, widow, Jan 31st 1762						

Drawing or Photograph

Inscription

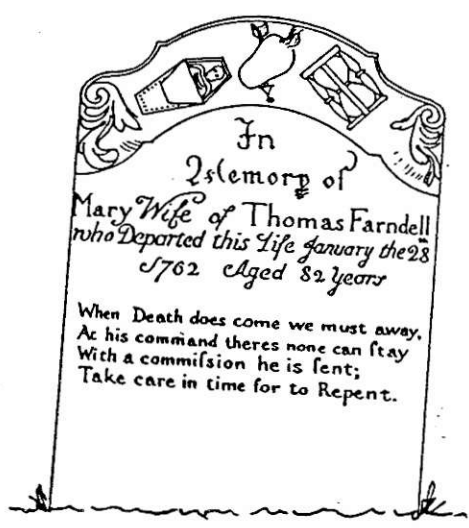

In
Memory of
Mary Wife of Thomas Farndell
who Departed this Life January the 28
1762 Aged 82 years.

When Death does come we must away,
At his command theres none can stay
With a commision he is sent;
Take care in time for to Repent.

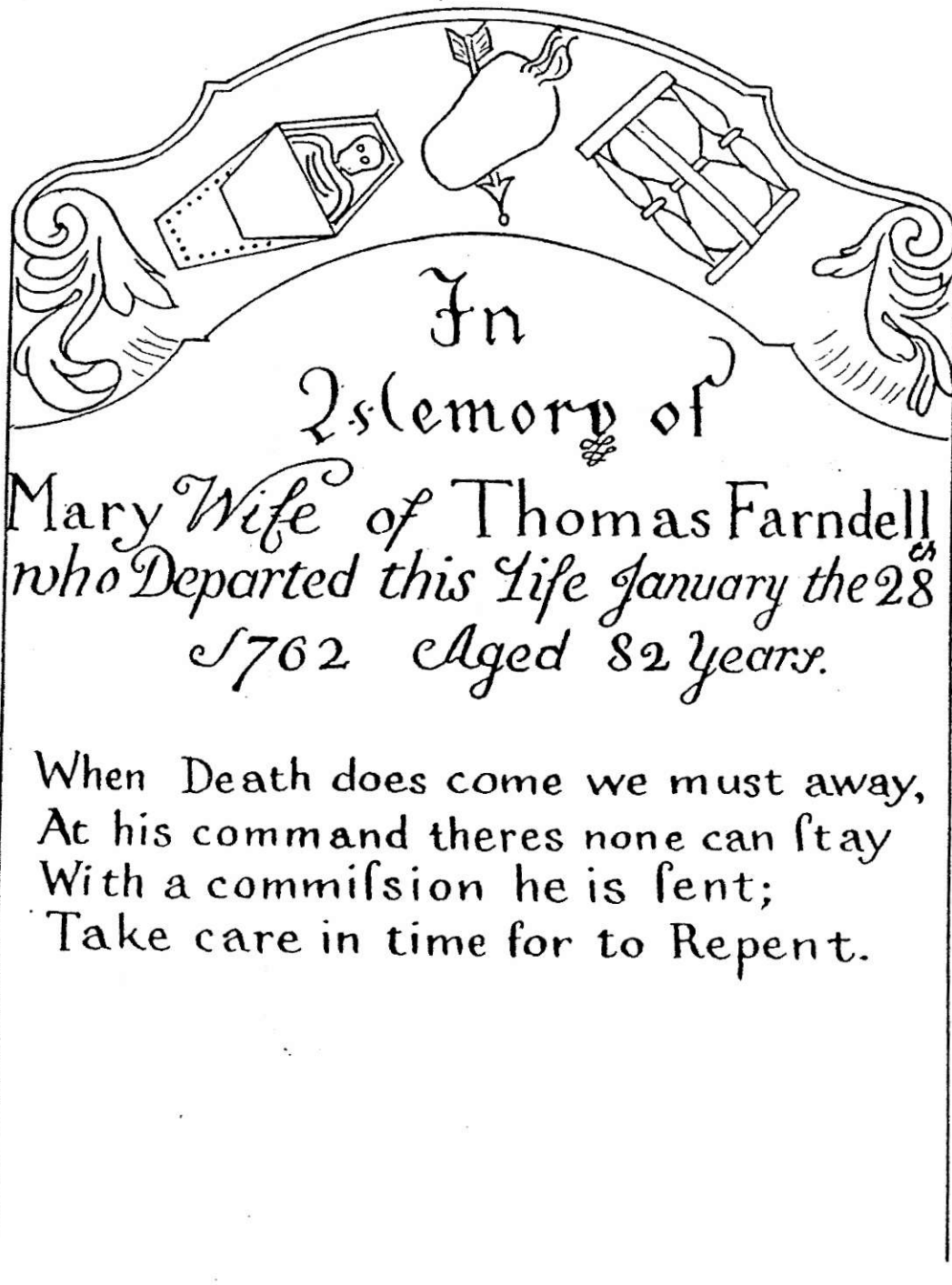

Grave Memorial Recording Form: St. John the Baptist, Westbourne, W. Sussex

1	National Grid Reference	755 073	Date	1	2	1	0	9	9	
2	Name of recorder(s)	DAPHNE COOPER								
3	Record No. of memorial (plus components i,ii,iii etc.)	N	W	B			1	4	7	
4	No. of components or inscribed faces (record on reverse if possible)									
5	Type of memorial: 1 = flat 2 = head 3 = tomb 4 = foot 5 = tablet 6 = other	2								
6	Material and geology	LIMESTONE								
7	Stone mason or undertaker	NONE FOUND								
8	Which surfaces inscribed (facing N, S, E or W)	E								
9	No. of people commemorated	3								
10	Condition of monument: 1=sound 2=displaced 3=leaning 4=collapsed 5=damaged	3								
11	Technique of inscription: 1 = incised 2 = carved in relief 3 = cast in relief 4 = lead letters 5 = painted	1								
12	Condition of inscription 1 = very good 2 = clear 3 = worn but decipherable 4 = partly legible 5 = illegible	3								
13	Dimensions (metric)	height	1	0	2	0	width	6	1	5
		Thickness (or length in case of tombs)			6	5				
14	Date of memorial	1803 + (or 1834)	Register	James Bishop bu. 25 Oct. 1803						
		Mary Bishop widow of the above J. Bishop bu. 4 Nov. 1803								
		Sarah Gregory, near Putney, bu. 6 May 1834 aged 58								
	Drawing or Photograph	Inscription								

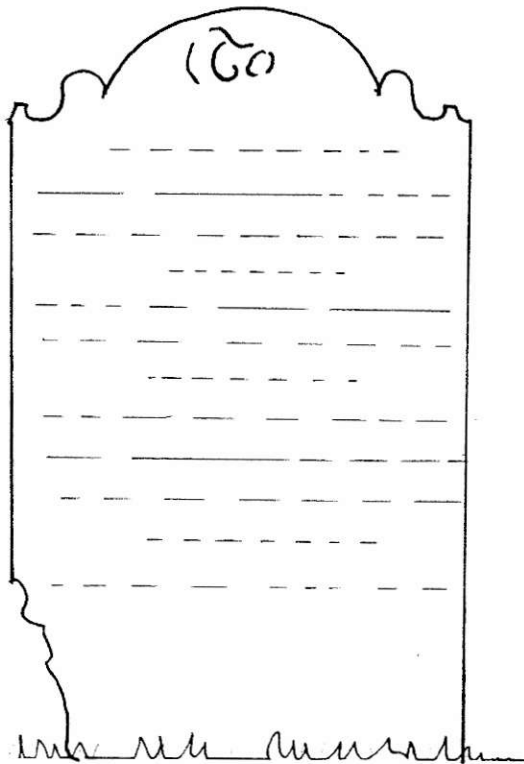

bottom left corner broken away

(60)

the Memory of
JAMES BISHOP who Died
 October the 25th in the year 1803
 Aged 64
 also his Wife **MARY BISHOP**
 who Died Nov. the 4th in the year 1803
 Aged 71
 And their beloved Daughter
SARAH GREGORY who Died
 April the 29th in the year 1834
 Aged 58
 at whose desire this stone was erected

Grave Memorial Recording Form: St. John the Baptist, Westbourne, W. Sussex

1	National Grid Reference	755 073	Date	3	1	0	8	9	9
2	Name of recorder(s)	John Lamplugh							
3	Record No. of memorial (plus components i,ii,iii etc.)	N	W	5			1	4	8
4	No. of components or inscribed faces (record on reverse if possible)								
5	Type of memorial: 1 = flat 2 = head 3 = tomb 4 = foot 5 = tablet 6 = other								
6	Material and geology	Limestone							
7	Stone mason or undertaker	None found							
8	Which surfaces inscribed (facing N, S, E or W)	E							
9	No. of people commemorated	1							
10	Condition of monument: 1=sound 2=displaced 3=leaning 4=collapsed 5=damaged	1							
11	Technique of inscription: 1 = incised 2 = carved in relief 3 = cast in relief 4 = lead letters 5 = painted	1							
12	Condition of inscription 1 = very good 2 = clear 3 = worn but decipherable 4 = partly legible 5 = illegible	3							
13	Dimensions (metric)	height	9	8	5	width	5	6	5
		Thickness (or length in case of tombs)		7	0				
14	Date of memorial	1756+	Register	not found					
Drawing or Photograph					Inscription				

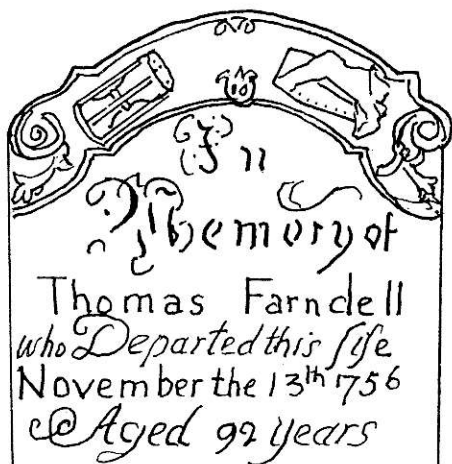

In
Memory of
Thomas Farndell
who Departed this life
November the 13th 1756
@ Aged 92 years

My Age you see is Ninety two
Such Ages now there are but few
My eyes were dim my strength decay'd
Now in the dust my Body's laid
In hopes that I shall Rise again
Exempt from Trouble free from Pain

Grave Memorial Recording Form: St. John the Baptist, Westbourne, W. Sussex

1	National Grid Reference	755 073	Date	3	1	0	8	9	9		
2	Name of recorder(s)	James Linder									
3	Record No. of memorial (plus components i,ii,iii etc.)	N	W	B				1	4	9	
4	No. of components or inscribed faces (record on reverse if possible)									1	
5	Type of memorial: 1 = flat 2 = head 3 = tomb 4 = foot 5 = tablet 6 = other									2	
6	Material and geology	STONE: LIMESTONE									
7	Stone mason or undertaker	NONE FOUND									
8	Which surfaces inscribed (facing N, S, E or W)									E	
9	No. of people commemorated									1	
10	Condition of monument: 1=sound 2=displaced 3=leaning 4=collapsed 5=damaged									1	3
11	Technique of inscription: 1 = incised 2 = carved in relief 3 = cast in relief 4 = lead letters 5 = painted										1
12	Condition of inscription 1 = very good 2 = clear 3 = worn but decipherable 4 = partly legible 5 = illegible										2
13	Dimensions (metric)			height		8	8	0			
				width		4	4	5			
				Thickness (or length in case of tombs)			5	0			
14	Date of memorial	1841+	Register	Frederick John Bluett, Prinstead bu. March 18, 1841 a-6 months							

Drawing or Photograph

Inscription

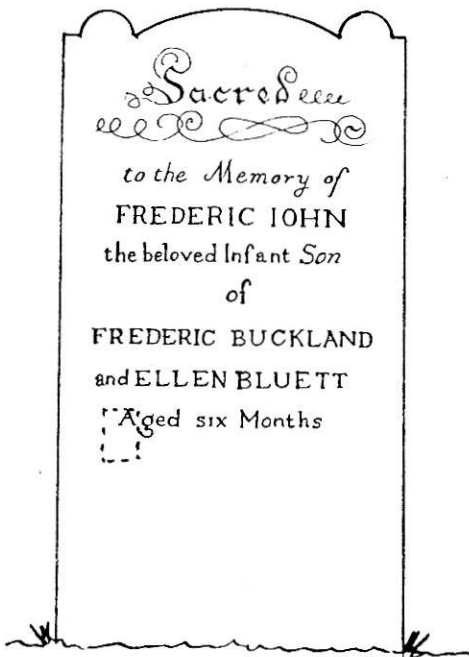

THE STONE HAS A PATCH WHERE SHOWN.

Sacred
 to the Memory of
 FREDERIC IOHN
 the beloved Infant Son
 of
 FREDERIC BUCKLAND
 and ELLEN BLUETT
 Aged six Months

NO DATE IS QUOTED ON THE STONE.

Grave Memorial Recording Form: St. John the Baptist, Westbourne, W. Sussex

1	National Grid Reference	755 073	Date	2	5	0	4	0	0						
2	Name of recorder(s)	DAPHNE COOPER													
3	Record No. of memorial (plus components i,ii,iii etc.)	N	W	B				1	5	0					
4	No. of components or inscribed faces (record on reverse if possible)									1					
5	Type of memorial: 1 = flat 2 = head 3 = tomb 4 = foot 5 = tablet 6 = other									3					
6	Material and geology	LIMESTONE													
7	Stone mason or undertaker	MOORE Havant													
8	Which surfaces inscribed (facing N, S, E or W)									S					
9	No. of people commemorated									1					
10	Condition of monument: 1=sound 2=displaced 3=leaning 4=collapsed 5=damaged									1					
11	Technique of inscription: 1 = incised 2 = carved in relief 3 = cast in relief 4 = lead letters 5 = painted									1					
12	Condition of inscription 1 = very good 2 = clear 3 = worn but decipherable 4 = partly legible 5 = illegible									3					
13	Dimensions (metric)	height	4	0	5	width	1	1	8	0	Thickness (or length in case of tombs)	2	4	4	0
14	Date of memorial	1845	Register John Day, Gosden Green bu. 28 March 1845, aged 76												
Drawing or Photograph												Inscription			

Mason's name

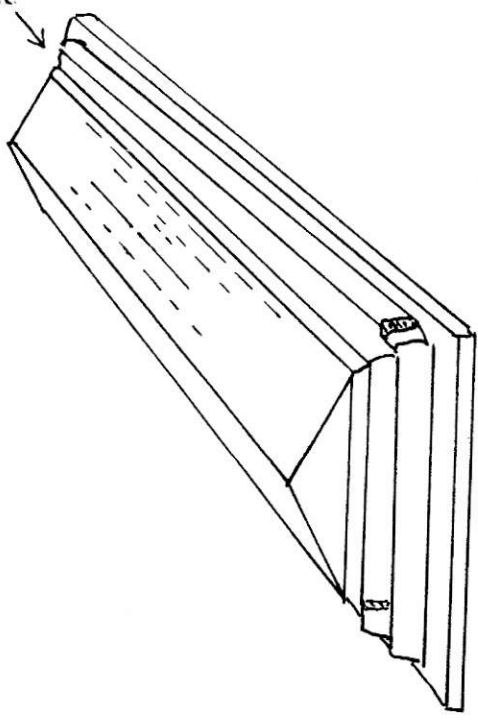

Mason's name on middle section E end

IN MEMORY OF
 JOHN DAY
 OF
 PRINSTED COTTAGE
 DIED 17 OF MARCH 1845 AGED 76 YEARS

Grave Memorial Recording Form: St. John the Baptist, Westbourne, W. Sussex

1	National Grid Reference	755 037	Date	1	2	1	0	9	9	
2	Name of recorder(s)	BERYL LINDER								
3	Record No. of memorial (plus components i,ii,iii etc.)	N	W	B			1	5	1	
4	No. of components or inscribed faces (record on reverse if possible)									
5	Type of memorial: 1 = flat 2 = head 3 = tomb 4 = foot 5 = tablet 6 = other	2								
6	Material and geology	LIMESTONE								
7	Stone mason or undertaker	NONE FOUND								
8	Which surfaces inscribed (facing N, S, E or W)	E								
9	No. of people commemorated	2								
10	Condition of monument: 1=sound 2=displaced 3=leaning 4=collapsed 5=damaged	1								
11	Technique of inscription: 1 = incised 2 = carved in relief 3 = cast in relief 4 = lead letters 5 = painted	1								
12	Condition of inscription 1 = very good 2 = clear 3 = worn but decipherable 4 = partly legible 5 = illegible	2								
13	Dimensions (metric)	height	1	5	3	0				
		width	1	0	5	0				
		Thickness (or length in case of tombs)					7	5		
14	Date of memorial	1805	Register William Dorey bu Dec. 22, 1804							
	Ann Dorey, widow, bu Jan. 10, 1805									
Drawing or Photograph					Inscription					

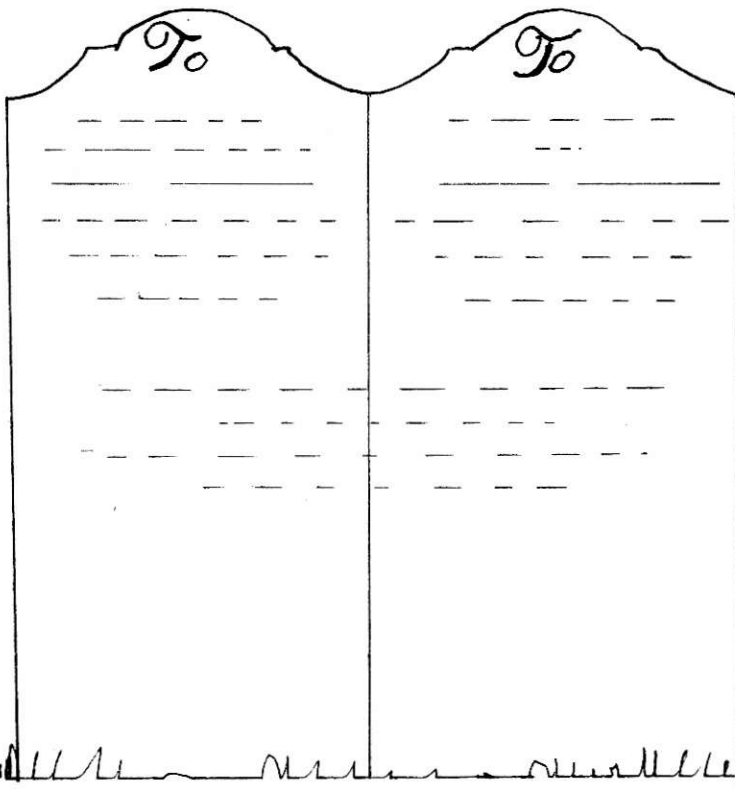

To
 the Memory
 of ANN Wife of
 WILLIAM DOREY
 who departed this Life
 January 7th 1805
 Aged 63 Years.

To
 the Memory
 of
 WILLIAM DOREY
 who departed this Life
 December 18th 1804.
 Aged 63 Years.

There is no Age that Death will spare
 All ages they must die :
 Therefore to die let all prepare
 To live Eternally.

Grave Memorial Recording Form: St. John the Baptist, Westbourne, W. Sussex

1	National Grid Reference	755 073	Date	2	5	0	4	0	0
2	Name of recorder(s)	KEITH LINDER							
3	Record No. of memorial (plus components i,ii,iii etc.)	N	W	B			1	5	2
4	No. of components or inscribed faces (record on reverse if possible)								
5	Type of memorial: 1 = flat 2 = head 3 = tomb 4 = foot 5 = tablet 6 = other								
6	Material and geology	STONE: LIMESTONE, PORTLAND TYPE							
7	Stone mason or undertaker	NONE FOUND							
8	Which surfaces inscribed (facing N, S, E or W)	E							
9	No. of people commemorated	1							
10	Condition of monument: 1=sound 2=displaced 3=leaning 4=collapsed 5=damaged	1							
11	Technique of inscription: 1 = incised 2 = carved in relief 3 = cast in relief 4 = lead letters 5 = painted	1							
12	Condition of inscription 1 = very good 2 = clear 3 = worn but decipherable 4 = partly legible 5 = illegible	3							
13	Dimensions (metric)	height	1	6	9	0			
		width		8	4	0			
		Thickness (or length in case of tombs)			7	5			
14	Date of memorial 1800+	Register Elizabeth W. of Thomas Clear, Junr. b. 18 June 1800							
Drawing or Photograph					Inscription				

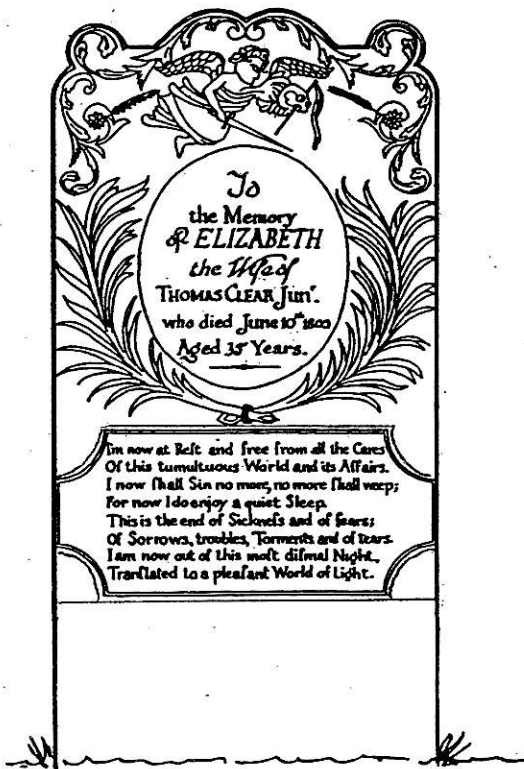

To
the Memory
of ELIZABETH
the Wife of
THOMAS CLEAR Junr.
who died June 10th 1800
Aged 35 Years.

I'm now at Rest and free from all the Cares
Of this tumultuous World and its Affairs;
I now shall Sin no more, no more shall weep;
For now I do enjoy a quiet Sleep.
This is the end of Sickness and of fears;
Of Sorrows, troubles, Torments and of tears.
I am now out of this most dismal Night,
Translated to a pleasant World of Light.

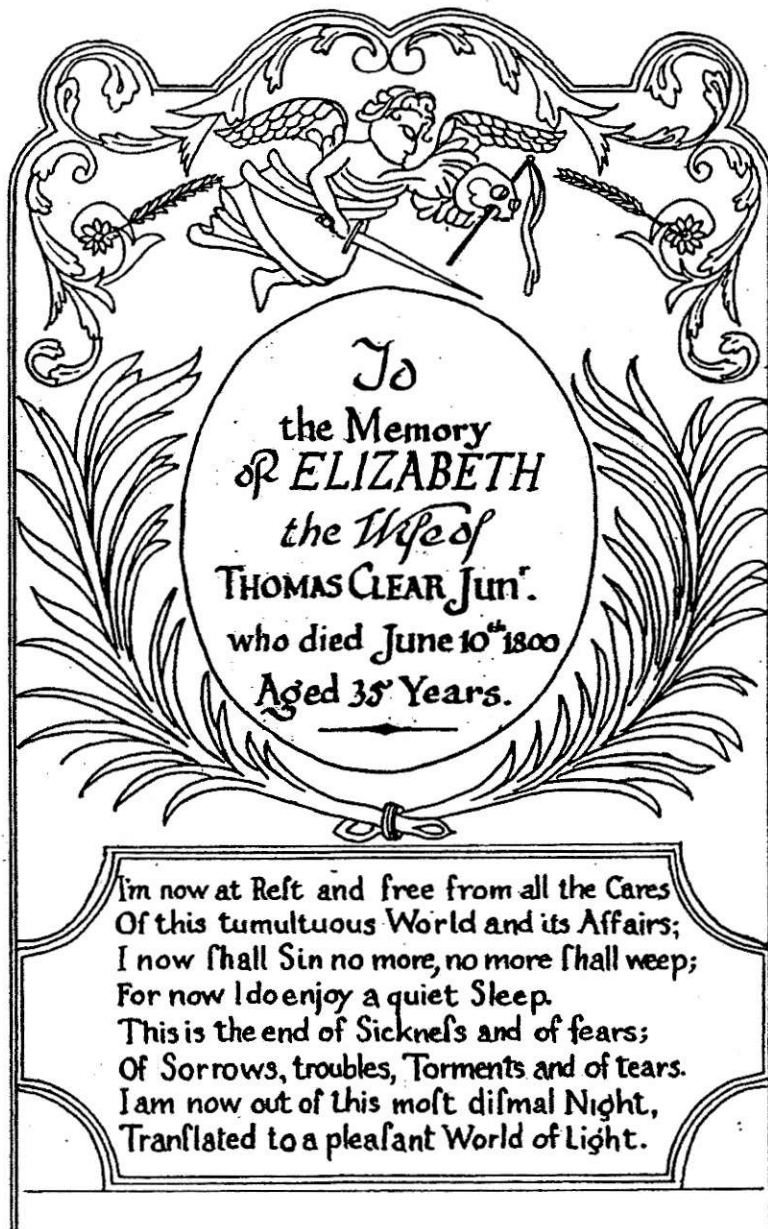

Grave Memorial Recording Form: St. John the Baptist, Westbourne, W. Sussex

1	National Grid Reference	755 073	Date	2	5	0	4	0	0
2	Name of recorder(s)	Beryl Linder							
3	Record No. of memorial (plus components i,ii,iii etc.)	N	W	B			1	5	3
4	No. of components or inscribed faces (record on reverse if possible)								
5	Type of memorial: 1 = flat 2 = head 3 = tomb 4 = foot 5 = tablet 6 = other	2							
6	Material and geology	LIMESTONE							
7	Stone mason or undertaker	NONE FOUND							
8	Which surfaces inscribed (facing N, S, E or W)	E							
9	No. of people commemorated	1							
10	Condition of monument: 1=sound 2=displaced 3=leaning 4=collapsed 5=damaged	1							
11	Technique of inscription: 1 = incised 2 = carved in relief 3 = cast in relief 4 = lead letters 5 = painted	1 5							
12	Condition of inscription 1 = very good 2 = clear 3 = worn but decipherable 4 = partly legible 5 = illegible	1							
13	Dimensions (metric)	height	1	6	5	0			
		width		8	1	0			
		Thickness (or length in case of tombs)			6	5			
14	Date of memorial	1844	Register	Abraham Miller Hermitage					
				64-19 April 1844 aged 50					
Drawing or Photograph					Inscription				

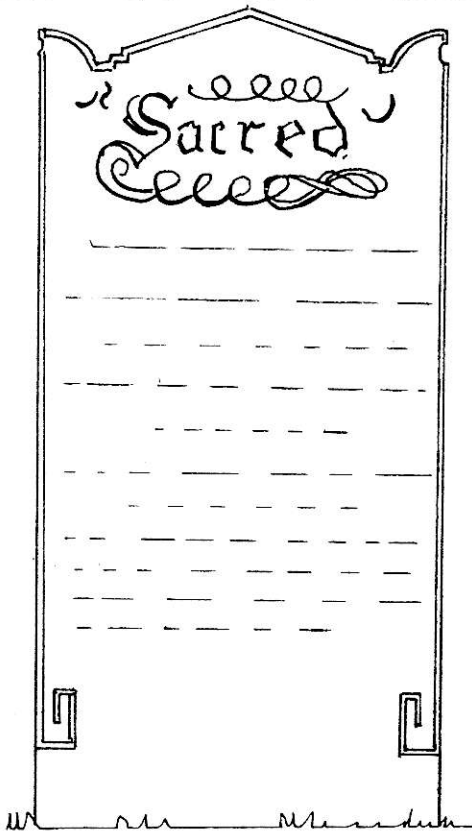

"Sacred"
to the Memory of
ABRAHAM MILLER
who departed this Life
on the 16. Day of April 1844
Aged 50 Years

Leaving a Wife and five Children
to lament his Loss.
Behold my strength soon wither'd away
and the number of my days were as a span long
Be merciful to thy servant O Lord at the last
for my hope is in Thee.

Text not found, but there are perhaps
reflexions of Ps. 39: 5, 6, 8, used in Burial Service

Grave Memorial Recording Form: St. John the Baptist, Westbourne, W. Sussex

1	National Grid Reference	755 073	Date	0	2	0	5	0	0
2	Name of recorder(s)	J. Storer							
3	Record No. of memorial (plus components i,ii,iii etc.)	N	W	B			1	5	4
4	No. of components or inscribed faces (record on reverse if possible)								
5	Type of memorial: 1 = flat 2 = head 3 = tomb 4 = foot 5 = tablet 6 = other								
6	Material and geology	limestone							
7	Stone mason or undertaker	none found							
8	Which surfaces inscribed (facing N, S, E or W)	E							
9	No. of people commemorated	2							
10	Condition of monument: 1=sound 2=displaced 3=leaning 4=collapsed 5=damaged	1							
11	Technique of inscription: 1 = incised 2 = carved in relief 3 = cast in relief 4 = lead letters 5 = painted	1							
12	Condition of inscription 1 = very good 2 = clear 3 = worn but decipherable 4 = partly legible 5 = illegible	2							
13	Dimensions (metric)	height	1	2	8	0			
		width		5	6	2			
		Thickness (or length in case of tombs)			6	5			
14	Date of memorial	1831 +	Register Henry Miller, Hermitage, bu. J Sept.						
		Kate Miller, Hermitage, bu. 4 Aug. 1856, aged 1 year and 1/2 // 1831 aged 2							
Drawing or Photograph					Inscription				

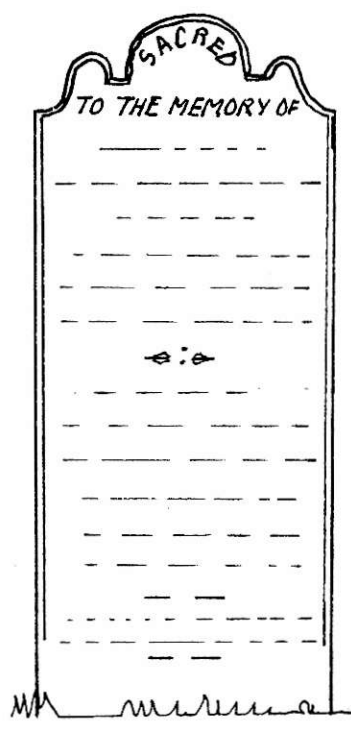

SACRED

TO THE MEMORY OF
HENRY, son of
ABRAHAM & ELIZABETH
MILLER
who departed this life
the 1st of September 1831.
Aged 2 Years and 7 Months

Also of KATE,
the beloved daughter of
ABRAHAM & EMILY MILLER
who departed this life
the 1st of August 1856.
Aged 7 Year and 5 Months.

The Lord gave and the Lord hath taken
away; blessed be the name of the Lord.

Grave Memorial Recording Form: St. John the Baptist, Westbourne, W. Sussex

1	National Grid Reference	755 073	Date	0	2	0	5	0	0
2	Name of recorder(s)	June Marshall							
3	Record No. of memorial (plus components i,ii,iii etc.)	N	W	B			1	5	5
4	No. of components or inscribed faces (record on reverse if possible)								1
5	Type of memorial: 1 = flat 2 = head 3 = tomb 4 = foot 5 = tablet 6 = other								2
6	Material and geology	Limestone, poor quality							
7	Stone mason or undertaker	Not known							
8	Which surfaces inscribed (facing N, S, E or W)								E
9	No. of people commemorated								2
10	Condition of monument: 1=sound 2=displaced 3=leaning 4=collapsed 5=damaged								1
11	Technique of inscription: 1 = incised 2 = carved in relief 3 = cast in relief 4 = lead letters 5 = painted								1
12	Condition of inscription 1 = very good 2 = clear 3 = worn but decipherable 4 = partly legible 5 = illegible								3
13	Dimensions (metric)	height	1	0	8	5			
		width		7	7	0			
		Thickness (or length in case of tombs)			6	2			
14	Date of memorial	1845+	Register	Robert Greer, Westbourne, bu. 22 May Margaret Greer, Westbourne, Westbourne, bu. 16 Oct. 1832, a. 64 // 1845, a. 79					
Drawing or Photograph					Inscription				

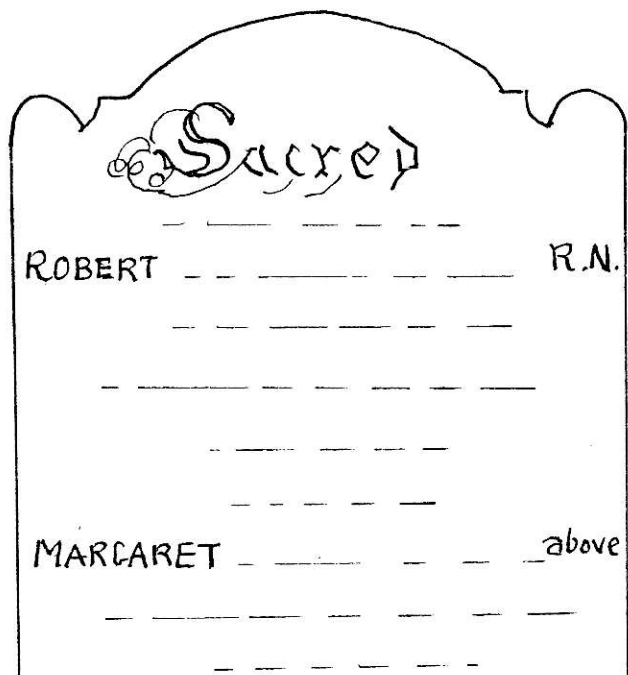

Sacred
to the Memory of
ROBERT GREER Surgeon in the R.M.
who departed this life
on the 17th of May 1845
Aged 79 Years.
Also of
MARGARET GREER wife of the above
who Died the 10th of October 1832
Aged 64 Years

June Marshall

Grave Memorial Recording Form: St. John the Baptist, Westbourne, W. Sussex

1	National Grid Reference	755 073	Date	0	9	0	5	0	0	
2	Name of recorder(s)	DAPHNE MERYON								
3	Record No. of memorial (plus components i,ii,iii etc.)		N	W	B			1	5	6
4	No. of components or inscribed faces (record on reverse if possible)									1
5	Type of memorial: 1 = flat 2 = head 3 = tomb 4 = foot 5 = tablet 6 = other									2
6	Material and geology	STONE: limestone								
7	Stone mason or undertaker	NONE FOUND								
8	Which surfaces inscribed (facing N, S, E or W)									E
9	No. of people commemorated									2
10	Condition of monument: 1=sound 2=displaced 3=leaning 4=collapsed 5=damaged									5
11	Technique of inscription: 1 = incised 2 = carved in relief 3 = cast in relief 4 = lead letters 5 = painted									1
12	Condition of inscription 1 = very good 2 = clear 3 = worn but decipherable 4 = partly legible 5 = illegible									3
13	Dimensions (metric)	height	1	0	6	0				
		width		7	2	5				
		Thickness (or length in case of tombs)			7	5				
14	Date of memorial	1823	Register	Elizabeth Fricker, Westbourne, bu. 12 July						
				Robert Fricker, Hermitage, bu. 16 Aug. 1845, a-78 // 1828, a-81						
Drawing or Photograph						Inscription				

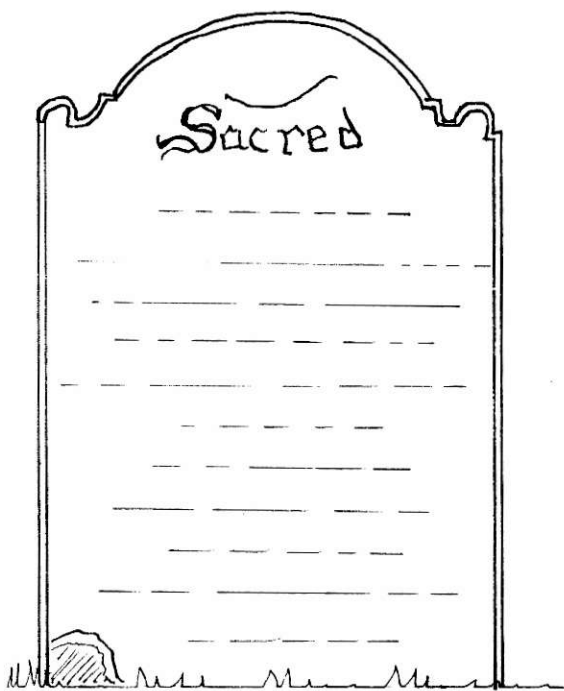

damage bottom left corner

Sacred
to the Memory of
 ELIZABETH FRICKER Widow
 of WILLIAM FRICKER. R.N.
 who departed this life
 on the 7th day of July 1823.
 aged 81 Years
 Also Her Son
 ROBERT FRICKER Esq^r
 Commander R.N.
 who died the 12th of August 1845
 Aged 78 Years

Grave Memorial Recording Form: St. John the Baptist, Westbourne, W. Sussex

1	National Grid Reference	755 073	Date	1	3	0	6	0	0	
2	Name of recorder(s)	JOSEPHINE HALLETT								
3	Record No. of memorial (plus components i,ii,iii etc.)	N	W	B			1	5	7	
4	No. of components or inscribed faces (record on reverse if possible)									
5	Type of memorial: 1 = flat 2 = head 3 = tomb 4 = foot 5 = tablet 6 = other									
6	Material and geology	LIMESTONE								
7	Stone mason or undertaker	NONE FOUND								
8	Which surfaces inscribed (facing N, S, E or W)	E								
9	No. of people commemorated	1								
10	Condition of monument: 1=sound 2=displaced 3=leaning 4=collapsed 5=damaged	1								
11	Technique of inscription: 1 = incised 2 = carved in relief 3 = cast in relief 4 = lead letters 5 = painted	1								
12	Condition of inscription 1 = very good 2 = clear 3 = worn but decipherable 4 = partly legible 5 = illegible	2								
13	Dimensions (metric)	height	1	1	3	5	width	6	6	0
		Thickness (or length in case of tombs)			7	0				
14	Date of memorial	1821+	Register	Jane Fricker, Racton, bu. 3 Feb. 1821 a. 43						
Drawing or Photograph						Inscription				

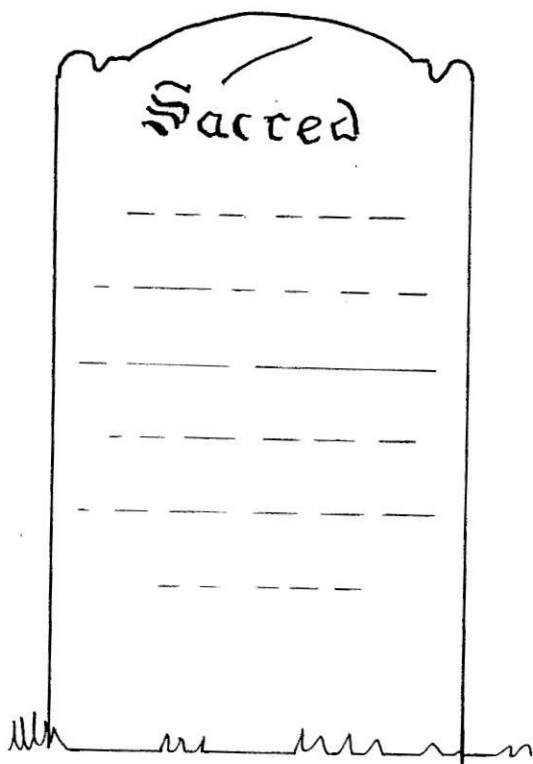

Sacred
 to the Memory of
 M^{rs} JANE. the Wife
 of M^r. EDWARD FRICKER.
 who departed this life
 the 29th day of January 1821.
 aged 51 Years.

discrepancy in age between inscription and register

Grave Memorial Recording Form: St. John the Baptist, Westbourne, W. Sussex

1	National Grid Reference	755 073	Date	1	0	0	5	0	0
2	Name of recorder(s)	JOHN LAMPLUGH							
3	Record No. of memorial (plus components i,ii,iii etc.)	N	W	B			1	5	8
4	No. of components or inscribed faces (record on reverse if possible)								
5	Type of memorial: 1 = flat 2 = head 3 = tomb 4 = foot 5 = tablet 6 = other	2							
6	Material and geology	LIMESTONE							
7	Stone mason or undertaker	NONE FOUND							
8	Which surfaces inscribed (facing N, S, E or W)	E							
9	No. of people commemorated	1							
10	Condition of monument: 1=sound 2=displaced 3=leaning 4=collapsed 5=damaged	1							
11	Technique of inscription: 1 = incised 2 = carved in relief 3 = cast in relief 4 = lead letters 5 = painted	1							
12	Condition of inscription 1 = very good 2 = clear 3 = worn but decipherable 4 = partly legible 5 = illegible	2							
13	Dimensions (metric)	height	1	3	1	0			
		width		6	6	0			
		Thickness (or length in case of tombs)			7	0			
14	Date of memorial	1842+	Register Elizabeth Bowden, Hermitage, bu. 19 March 1842 aged 66						
Drawing or Photograph					Inscription				

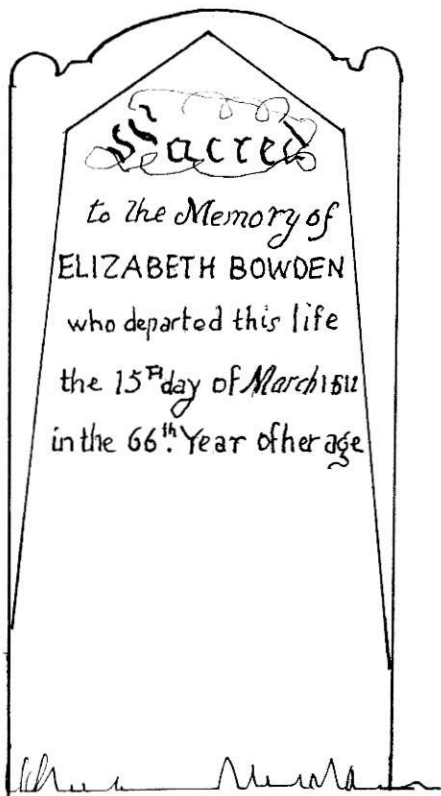



Sacred
to the Memory of
ELIZABETH BOWDEN
who departed this life
the 15th day of March 1842
in the 66th Year of her age

(Sperling's record no..184..)

Grave Memorial Recording Form: St. John the Baptist, Westbourne, W. Sussex

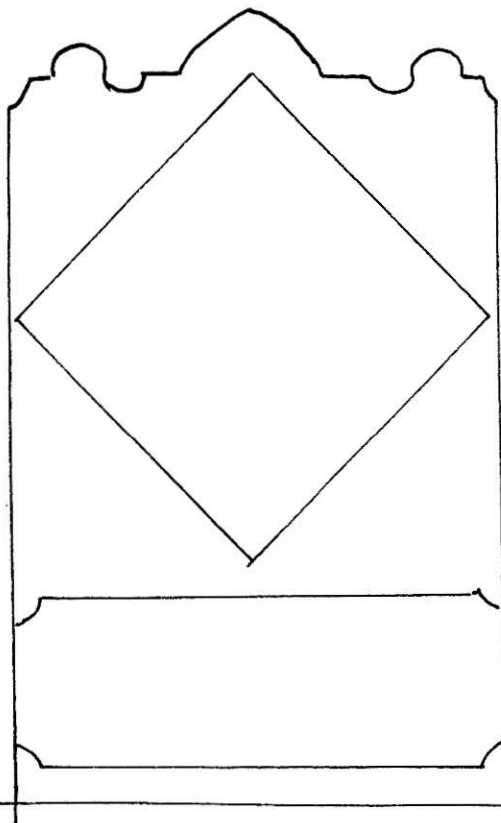
1	National Grid Reference	755 073	Date	1	5	5	20	00
2	Name of recorder(s)	SHIRLEY HARVEY-WHITING.						
3	Record No. of memorial (plus components i,ii,iii etc.)	N	W	B	1	5	9	
4	No. of components or inscribed faces (record on reverse if possible)							
5	Type of memorial: 1 = flat 2 = head 3 = tomb 4 = foot 5 = tablet 6 = other	2						
6	Material and geology	LIMESTONE						
7	Stone mason or undertaker	none found						
8	Which surfaces inscribed (facing N, S, E or W)	E						
9	No. of people commemorated	1						
10	Condition of monument: 1=sound 2=displaced 3=leaning 4=collapsed 5=damaged	3						
11	Technique of inscription: 1 = incised 2 = carved in relief 3 = cast in relief 4 = lead letters 5 = painted	1						
12	Condition of inscription 1 = very good 2 = clear 3 = worn but decipherable 4 = partly legible 5 = illegible	2						
13	Dimensions (metric)	height	1	1	5	5		
		width		7	8	5		
		Thickness (or length in case of tombs)				7		
14	Date of memorial	1810+	Register Martha Mansbridge bn. 30 Sept. 1810, a. 61					
Drawing or Photograph				Inscription				





The Memory
 of MARTHA Wife of
 JOHN MANSBRIDGE
 who departed this Life
 the 26. of September 1810
Aged 61 Years.

*Why should we Mourn for one who nows in Peace
 Whose quiet Soul enjoys eternal Rest
 Beyond the reach of Wee she sours above,
 Safe in the Arms of everlasting Love.*

Grave Memorial Recording Form: St. John the Baptist, Westbourne, W. Sussex

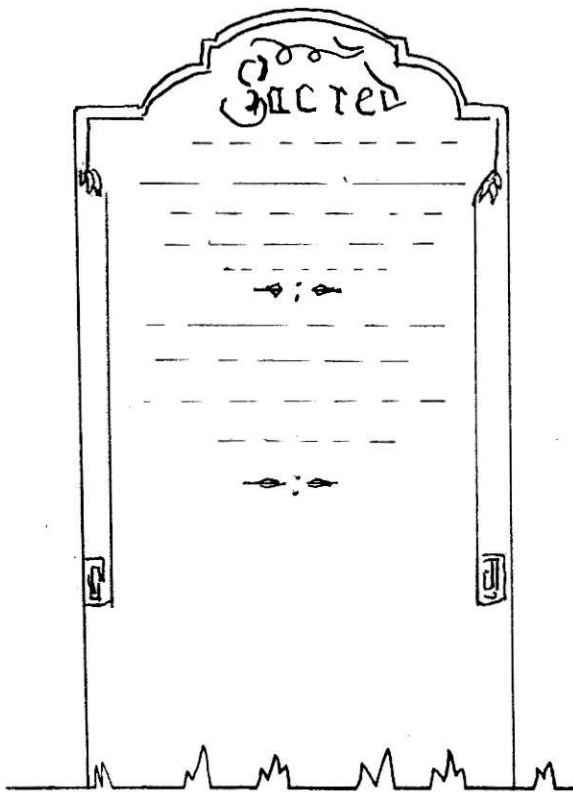
1	National Grid Reference	755 073	Date	0	9	0	5	0	0
2	Name of recorder(s)	BERYL LINDER							
3	Record No. of memorial (plus components i,ii,iii etc.)	N	W	B			1	6	0
4	No. of components or inscribed faces (record on reverse if possible)								
5	Type of memorial: 1 = flat 2 = head 3 = tomb 4 = foot 5 = tablet 6 = other								
6	Material and geology	LIMESTONE							
7	Stone mason or undertaker	NONE FOUND							
8	Which surfaces inscribed (facing N, S, E or W)								
9	No. of people commemorated								
10	Condition of monument: 1=sound 2=displaced 3=leaning 4=collapsed 5=damaged								
11	Technique of inscription: 1 = incised 2 = carved in relief 3 = cast in relief 4 = lead letters 5 = painted								
12	Condition of inscription 1 = very good 2 = clear 3 = worn but decipherable 4 = partly legible 5 = illegible								
13	Dimensions (metric)	height	1	4	0	0			
		width		7	6	0			
		Thickness (or length in case of tombs)			6	5			
14	Date of memorial	1859 +	Register William Pile, Nutbourne, bu. 15 Nov. 1859 age 90 - Jemima not found						
Drawing or Photograph					Inscription				



Sacred

TO THE MEMORY OF
WILLIAM PILE,
 who departed this life.
 the 11th of November 1859.
Aged 70 Years.

♦ : ♦

And of **JEMIMA,** his wife.
 who departed this life.
 the 6th of January 1846.
Aged 60 Years.

♦ : ♦

Discrepancy in Williams age: 70 on stone
 90 in register (both checked)

Grave Memorial Recording Form: St. John the Baptist, Westbourne, W. Sussex

1	National Grid Reference	755 073	Date	0	9	0	5	0	0
2	Name of recorder(s)	JOSEPHINE HALLETT							
3	Record No. of memorial (plus components i,ii,iii etc.)	N	W	B			1	6	1
4	No. of components or inscribed faces (record on reverse if possible)								
5	Type of memorial: 1 = flat 2 = head 3 = tomb 4 = foot 5 = tablet 6 = other								
6	Material and geology	LIMESTONE							
7	Stone mason or undertaker	NONE FOUND							
8	Which surfaces inscribed (facing N, S, E or W)	E							
9	No. of people commemorated	1							
10	Condition of monument: 1=sound 2=displaced 3=leaning 4=collapsed 5=damaged	3							
11	Technique of inscription: 1 = incised 2 = carved in relief 3 = cast in relief 4 = lead letters 5 = painted	1							
12	Condition of inscription 1 = very good 2 = clear 3 = worn but decipherable 4 = partly legible 5 = illegible	3							
13	Dimensions (metric)	height	1	3	3	0			
		width		6	7	5			
		Thickness (or length in case of tombs)			6	5			
14	Date of memorial	1838 +	Register Charlotte Dickinson, Westbourne bu-29 Aug. 1838 a-28						
Drawing or Photograph					Inscription				

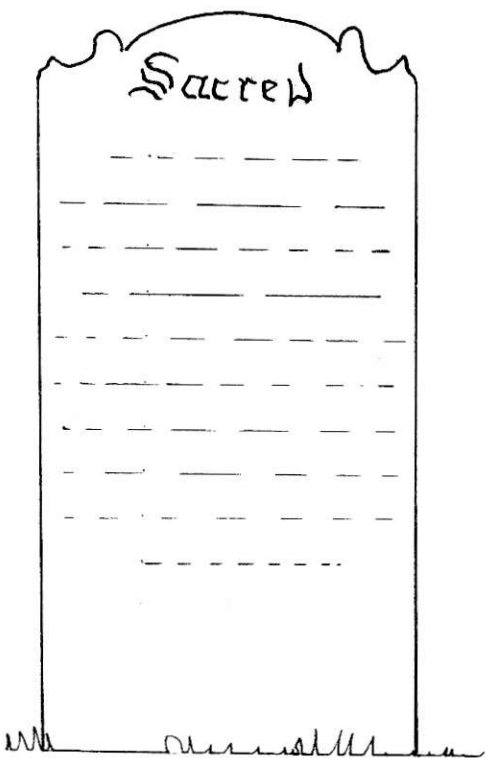

Sacred
to the Memory of
M^{rs} CHARLOTTE DICKINSON
the beloved and esteemed Wife of
M^r JOHN DICKINSON
of Weston Street Pentonville in the Parish
of Saint James Clerkenwell London
and Daughter of RICHARD and
MARY GUYATT of this Parish
who Died the 26th of August 1838
Aged 28 Years.

Grave Memorial Recording Form: St. John the Baptist, Westbourne, W. Sussex

1	National Grid Reference	755 073	Date	2	5	0	4	0	0
2	Name of recorder(s)	J. Storer							
3	Record No. of memorial (plus components i,ii,iii etc.)	N W 3		1		6		2	
4	No. of components or inscribed faces (record on reverse if possible)								
5	Type of memorial: 1 = flat 2 = head 3 = tomb 4 = foot 5 = tablet 6 = other								
6	Material and geology	stone: limestone							
7	Stone mason or undertaker	none found							
8	Which surfaces inscribed (facing N, S, E or W)	probably						E	
9	No. of people commemorated	not known							
10	Condition of monument: 1=sound 2=displaced 3=leaning 4=collapsed 5=damaged								
11	Technique of inscription: 1 = incised 2 = carved in relief 3 = cast in relief 4 = lead letters 5 = painted	none remains							
12	Condition of inscription 1 = very good 2 = clear 3 = worn but decipherable 4 = partly legible 5 = illegible	none remains							
13	Dimensions (metric)	height		7	3	2			
		width		6	5	2			
		Thickness (or length in case of tombs)			6	7			
14	Date of memorial	Register							
Drawing or Photograph		Inscription							

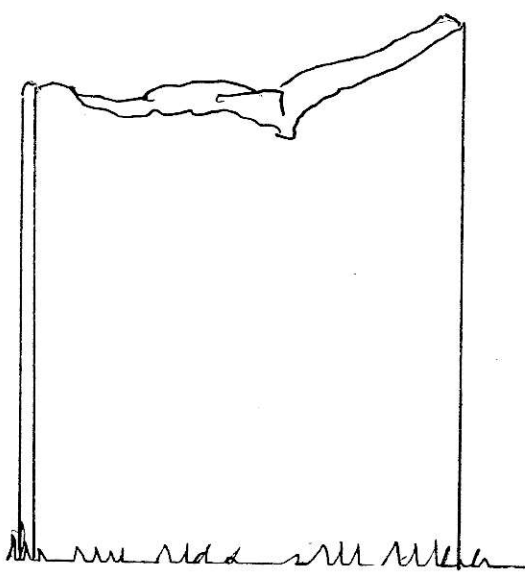

[none remains]

Grave Memorial Recording Form: St. John the Baptist, Westbourne, W. Sussex

1	National Grid Reference	755 073	Date	0	9	0	5	0	0
2	Name of recorder(s)	BERYL LINDER							
3	Record No. of memorial (plus components i,ii,iii etc.)	N	W	B			1	6	3
4	No. of components or inscribed faces (record on reverse if possible)								
5	Type of memorial: 1 = flat 2 = head 3 = tomb 4 = foot 5 = tablet 6 = other								
6	Material and geology	LIMESTONE							
7	Stone mason or undertaker	NONE FOUND							
8	Which surfaces inscribed (facing N, S, E or W)	E							
9	No. of people commemorated	1							
10	Condition of monument: 1=sound 2=displaced 3=leaning 4=collapsed 5=damaged	1							
11	Technique of inscription: 1 = incised 2 = carved in relief 3 = cast in relief 4 = lead letters 5 = painted	1							
12	Condition of inscription 1 = very good 2 = clear 3 = worn but decipherable 4 = partly legible 5 = illegible	2							
13	Dimensions (metric)	height	1	1	5	0			
		width		6	2	0			
		Thickness (or length in case of tombs)			6	5			
14	Date of memorial	1840 +	Register Mary Anne Savery, Hermitage bu 5 May 1840 a. 48						
Drawing or Photograph					Inscription				

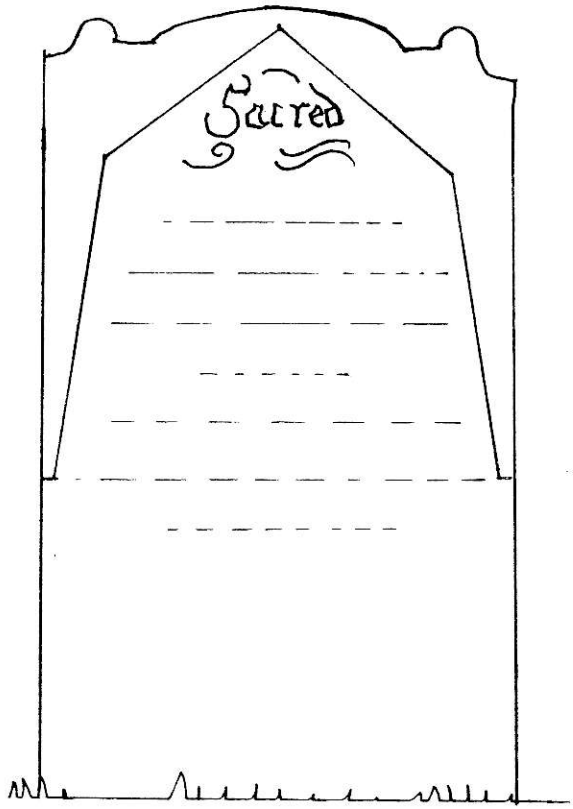

Sacred

to the Memory of
 MARY ANN Wife of
 JOHN ROBT. SAVERY ESQ
 Surgeon
 Trinidad West Indies
 who Died the 1st of May 1840
 Aged 51 Years

discrepancy in age between inscription and register

Grave Memorial Recording Form: St. John the Baptist, Westbourne, W. Sussex

1	National Grid Reference	755 073	Date	2	5	0	4	0	0	
2	Name of recorder(s)	BERYL LINDER								
3	Record No. of memorial (plus components i,ii,iii etc.)	N	W	B			1	6	4	
4	No. of components or inscribed faces (record on reverse if possible)									
5	Type of memorial: 1 = flat 2 = head 3 = tomb 4 = foot 5 = tablet 6 = other	uncertain whether a top of a table tomb fallen, or a cut down headstone							10	2
6	Material and geology	LIMESTONE								
7	Stone mason or undertaker	NONE FOUND								
8	Which surfaces inscribed (facing N, S, E or W)	not known								2
9	No. of people commemorated									
10	Condition of monument: 1=sound 2=displaced 3=leaning 4=collapsed 5=damaged	prob. displaced							2	4
11	Technique of inscription: 1 = incised 2 = carved in relief 3 = cast in relief 4 = lead letters 5 = painted									
12	Condition of inscription 1 = very good 2 = clear 3 = worn but decipherable 4 = partly legible 5 = illegible									
13	Dimensions (metric)	height	1	0	3	0	width	5	8	0
		Thickness (or length in case of tombs)			9	0				
14	Date of memorial	1846+	Register Edwin O'Brien Pitney, Westbourne, bu. 23 Dec. 1854. // 4 Feb. 1846, a.3							
		Walter Hatfield Pitney, Westbourne, bu. 23 Dec. 1854.								
	Drawing or Photograph	Inscription								

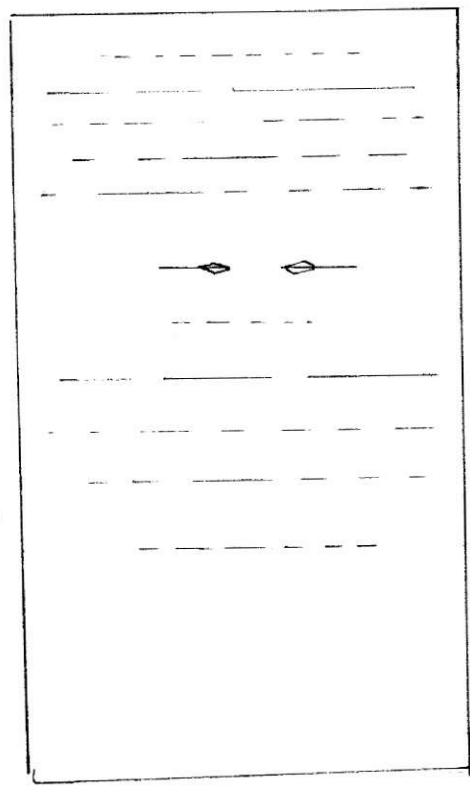

In memory of
EDWIN OBRIEN PITNEY
 son of JOHN SANN PITNEY Sen^r
 who died January 28th 1846
 Aged 3 Years and 3 Months

Also of

WALTER HARFIELD PITNEY
 son of JAMES & ELIZ[A] PITNEY Jnr.
 who died December 20th 1854
 Aged 6 Days

Edges are bevelled on inscription face.

Grave Memorial Recording Form: St. John the Baptist, Westbourne, W. Sussex

1	National Grid Reference	755 073	Date	0	2	0	5	0	0
2	Name of recorder(s)	BERYL LINDER							
3	Record No. of memorial (plus components i,ii,iii etc.)	N	W	B			1	6	5
4	No. of components or inscribed faces (record on reverse if possible)								
5	Type of memorial: 1 = flat 2 = head 3 = tomb 4 = foot 5 = tablet 6 = other	4							
6	Material and geology	LIMESTONE							
7	Stone mason or undertaker	NONE FOUND							
8	Which surfaces inscribed (facing N, S, E or W)	E							
9	No. of people commemorated	1							
10	Condition of monument: 1=sound 2=displaced 3=leaning 4=collapsed 5=damaged	1							
11	Technique of inscription: 1 = incised 2 = carved in relief 3 = cast in relief 4 = lead letters 5 = painted	1							
12	Condition of inscription 1 = very good 2 = clear 3 = worn but decipherable 4 = partly legible 5 = illegible	2							
13	Dimensions (metric)	height	9	7	0	width	5	7	0
		Thickness (or length in case of tombs)		6	0				
14	Date of memorial	1857+	Register	Benjamin Silver, Westbourne, bu. 8 May 1857 a. 19					
Drawing or Photograph					Inscription				

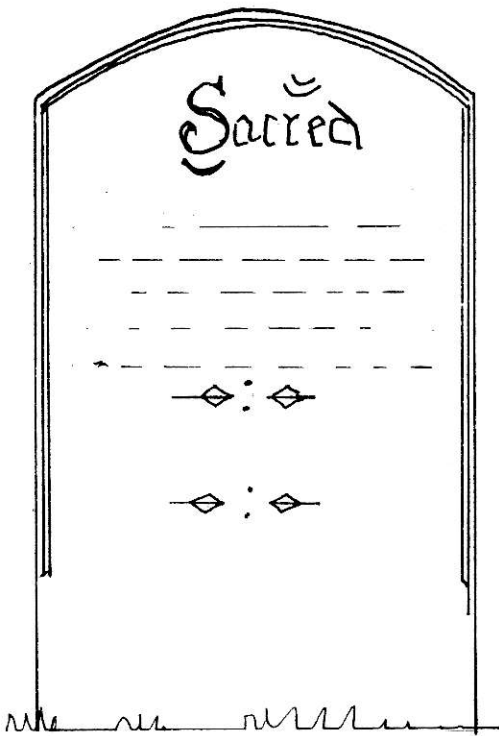

Sacred

TO THE MEMORY OF
BENJAMIN SILVER
 who departed this life
 the 4th of May 1857
 in the 20th year of his age

A loving Son lie buried here.
 Long were his pains and most severe.

line 7: Lie sic

Grave Memorial Recording Form: St. John the Baptist, Westbourne, W. Sussex

1	National Grid Reference	755 073	Date	1	6	0	5	0	0
2	Name of recorder(s)	JOHN LAMPLUGH							
3	Record No. of memorial (plus components i,ii,iii etc.)	N	E	B			1	6	6
4	No. of components or inscribed faces (record on reverse if possible)								
5	Type of memorial: 1 = flat 2 = head 3 = tomb 4 = foot 5 = tablet 6 = other								
6	Material and geology	limestone: a coarse type							
7	Stone mason or undertaker	none found							
8	Which surfaces inscribed (facing N, S, E or W)								
9	No. of people commemorated								
10	Condition of monument: 1=sound 2=displaced 3=leaning 4=collapsed 5=damaged								
11	Technique of inscription: 1 = incised 2 = carved in relief 3 = cast in relief 4 = lead letters 5 = painted								
12	Condition of inscription 1 = very good 2 = clear 3 = worn but decipherable 4 = partly legible 5 = illegible								
13	Dimensions (metric)	height	1	1	4	0			
		width		6	1	5			
		Thickness (or length in case of tombs)			7	0			
14	Date of memorial	1799+	Register John Hoare bu. 2 Nov. 1779						

Drawing or Photograph

Inscription

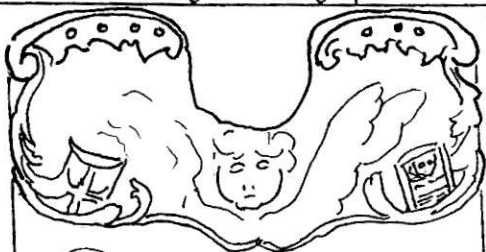

In Memory
of JOHN HOARE
Son of Joseph & Mary Hoare
who Died November the 2^d 1777
Aged 49 Years

We hope this change is for the best
To live with CHRIST and lie at rest

In Memory
of JOHN HOARE
Son of Joseph [&] Mary Hoare
who Died November the 2^d 1779
Aged 49 Years

We hope this change is for the best
To live with CHRIST and lie at rest

* same day given for death & burial.
Year unclear; could possibly be 1779
rather than 1777.