

Grave Memorial Recording Form: St. John the Baptist, Westbourne, W. Sussex

1	National Grid Reference	755 073	Date	16	6	0	5	0	0
2	Name of recorder(s)	Veronica JAY							
3	Record No. of memorial (plus components i,ii,iii etc.)	N E B 1 6 7							
4	No. of components or inscribed faces (record on reverse if possible)	1							
5	Type of memorial: 1 = flat 2 = head 3 = tomb 4 = foot 5 = tablet 6 = other	2							
6	Material and geology	LIMESTONE							
7	Stone mason or undertaker	NONE FOUND							
8	Which surfaces inscribed (facing N, S, E or W)								W
9	No. of people commemorated								1
10	Condition of monument: 1=sound 2=displaced 3=leaning 4=collapsed 5=damaged								5 I
11	Technique of inscription: 1 = incised 2 = carved in relief 3 = cast in relief 4 = lead letters 5 = painted								1
12	Condition of inscription 1 = very good 2 = clear 3 = worn but decipherable 4 = partly legible 5 = illegible								3
13	Dimensions (metric)	height	9	6	0	width	6	2	0
		Thickness (or length in case of tombs)		6	0				
14	Date of memorial	1775 or 1777	Register not found (register missing for much of 1775)						

Drawing or Photograph

Inscription



In Memory of

In Memory of
EDWARD HOARE

Son of JOSEPH & HANNAH HOARE
who Died March the 31 1777
in the 28th Year of His Age

Why mourn we for our well departed Friend
Since Death all Sin and care and Sorrow end
A Life well spent will at the Last bring peace
And Joys Divine that never more shall cease

cherub, hour glass, trumpets, open book

Grave Memorial Recording Form: St. John the Baptist, Westbourne, W. Sussex

1	National Grid Reference	755 073	Date	1	6	0	5	0	0
2	Name of recorder(s)	DAPHNE COOPER							
3	Record No. of memorial (plus components i,ii,iii etc.)	N	E	B			1	6	8
4	No. of components or inscribed faces (record on reverse if possible)								
5	Type of memorial: 1 = flat 2 = head 3 = tomb 4 = foot 5 = tablet 6 = other	2							
6	Material and geology	LIMESTONE: a finely grained fossiliferous type, poss. Purbeck							
7	Stone mason or undertaker	NONE FOUND							
8	Which surfaces inscribed (facing N, S, E or W)								W
9	No. of people commemorated	1							
10	Condition of monument: 1=sound 2=displaced 3=leaning 4=collapsed 5=damaged	3							
11	Technique of inscription: 1 = incised 2 = carved in relief 3 = cast in relief 4 = lead letters 5 = painted	1							
12	Condition of inscription 1 = very good 2 = clear 3 = worn but decipherable 4 = partly legible 5 = illegible	3							
13	Dimensions (metric)	height	8	3	0	width	5	7	0
		Thickness (or length in case of tombs)		9	0				
14	Date of memorial	1733+	Register Mary w. of Joseph Hoar bu. 2 nd Feb 1733						
Drawing or Photograph					Inscription				

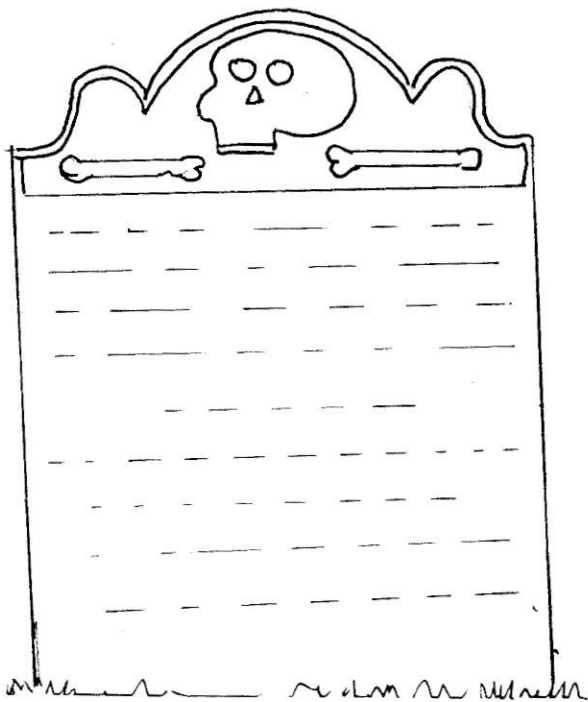

In Memory of Mary
 Hoare Wife of Ioseph
 Hoare who Departed this
 Life Jan: ^ye 31: 1733
 Aged 26 Years
 my time on Earth
 was Short to Stay
 but When God Calls
 wee must away

Grave Memorial Recording Form: St. John the Baptist, Westbourne, W. Sussex

1	National Grid Reference	755 073	Date	1	6	0	5	0	0	
2	Name of recorder(s)	DAPHNE COOPER								
3	Record No. of memorial (plus components i,ii,iii etc.)	N E B 1 6 9								
4	No. of components or inscribed faces (record on reverse if possible)	1								
5	Type of memorial: 1 = flat 2 = head 3 = tomb 4 = foot 5 = tablet 6 = other	2								
6	Material and geology	LIME STONE								
7	Stone mason or undertaker	NONE FOUND								
8	Which surfaces inscribed (facing N, S, E or W)	W								
9	No. of people commemorated	2								
10	Condition of monument: 1=sound 2=displaced 3=leaning 4=collapsed 5=damaged	3								
11	Technique of inscription: 1 = incised 2 = carved in relief 3 = cast in relief 4 = lead letters 5 = painted	1 5								
12	Condition of inscription 1 = very good 2 = clear 3 = worn but decipherable 4 = partly legible 5 = illegible	3								
13	Dimensions (metric)	height	1	3	7	0	width	7	3	5
		Thickness (or length in case of tombs)			7	0				
14	Date of memorial	? 1849	Register	Ann Miller, Emsworth, bu. 7 Feb. 1835						
		Abraham Miller, Emsworth, bu. 9 Feb. 1849 a-78 //		a-62						
Drawing or Photograph						Inscription				

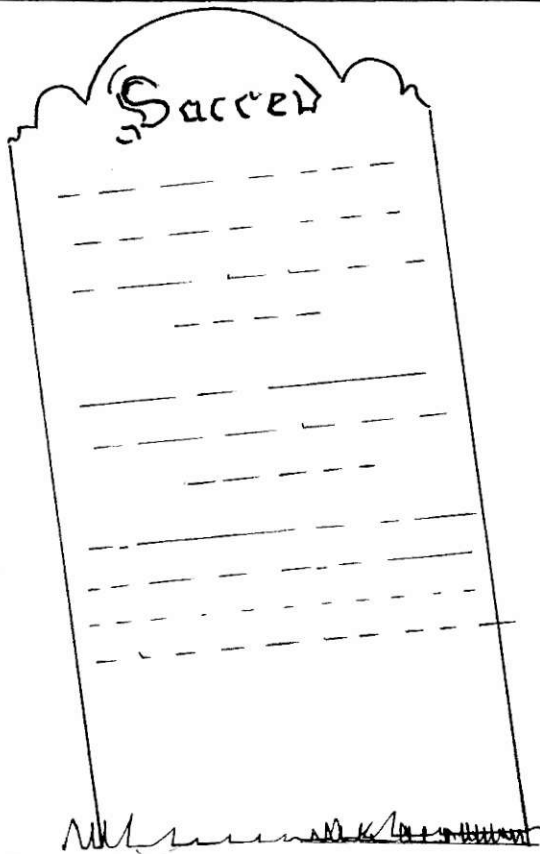

Sacred
 to the Memory of
 ABRAHAM MILLER
 who died the 5th of February 1849
 Aged 78 Years
 ANN MILLER who departed
 this life the 3rd of February 1835
 Aged 60 Years
 If a woman die shall she live again
 all the days of my appointed time
 will I wait till my change come.

Grave Memorial Recording Form: St. John the Baptist, Westbourne, W. Sussex

1	National Grid Reference	755 073	Date	3	0	0	5	0	0	
2	Name of recorder(s)	BERYL LINDER								
3	Record No. of memorial (plus components i,ii,iii etc.)	N E B		1		7		0		
4	No. of components or inscribed faces (record on reverse if possible)									
5	Type of memorial: 1 = flat 2 = head 3 = tomb 4 = foot 5 = tablet 6 = other	2								
6	Material and geology	LIMESTONE: PORTLAND/PURBECK TYPE								
7	Stone mason or undertaker	NOT FOUND								
8	Which surfaces inscribed (facing N, S, E or W)								W	
9	No. of people commemorated	2								
10	Condition of monument: 1=sound 2=displaced 3=leaning 4=collapsed 5=damaged								1	3
11	Technique of inscription: 1 = incised 2 = carved in relief 3 = cast in relief 4 = lead letters 5 = painted									1
12	Condition of inscription 1 = very good 2 = clear 3 = worn but decipherable 4 = partly legible 5 = illegible									3
13	Dimensions (metric)	height	1	0	1	0	width	8	6	0
		Thickness (or length in case of tombs)			8	0				
14	Date of memorial	1775+ (1760 or 1766+ Register not found (May-Nov. 1775 missing))								
Drawing or Photograph					Inscription					

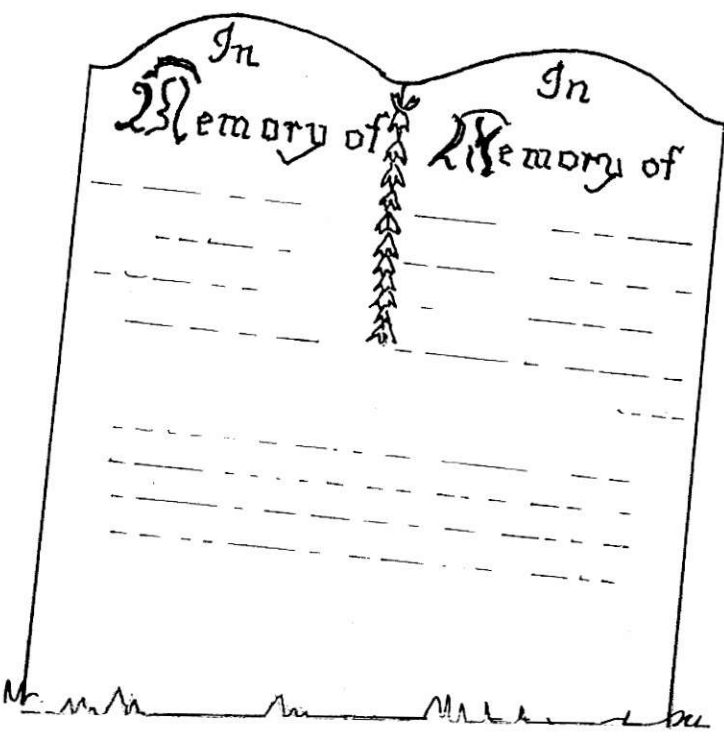

In Memory of Joseph Hoare
who Died April the 3 1766 *
Aged 66 Years

In Memory of Hannah Hoare
Wife of Jol^h Hoare
who Died August the 14th 1775
Aged 6^[3] Years

Kind Angels watch their Sleeping dust
Till Jesus comes to Rise the Just
Then may they wake [in sweet] Surprise
And in their Saviours Image rise

* could be 1760

Grave Memorial Recording Form: St. John the Baptist, Westbourne, W. Sussex

1	National Grid Reference	755 073	Date	1	3	0	6	0	0
2	Name of recorder(s)	DAPHNE MERYON							
3	Record No. of memorial (plus components i,ii,iii etc.)	N E B 1 7 1							
4	No. of components or inscribed faces (record on reverse if possible)	1							
5	Type of memorial: 1 = flat 2 = head 3 = tomb 4 = foot 5 = tablet 6 = other	2							
6	Material and geology	LIMESTONE							
7	Stone mason or undertaker	NONE FOUND							
8	Which surfaces inscribed (facing N, S, E or W)	W							
9	No. of people commemorated	1							
10	Condition of monument: 1=sound 2=displaced 3=leaning 4=collapsed 5=damaged	3							
11	Technique of inscription: 1 = incised 2 = carved in relief 3 = cast in relief 4 = lead letters 5 = painted	1							
12	Condition of inscription 1 = very good 2 = clear 3 = worn but decipherable 4 = partly legible 5 = illegible	4							
13	Dimensions (metric)	height	1	4	4	0			
		width		6	9	0			
		Thickness (or length in case of tombs)			7	5			
14	Date of memorial	1828+	Register John Hoare, Westbourne, bu. 23 July 1828 a. 74						
Drawing or Photograph					Inscription				

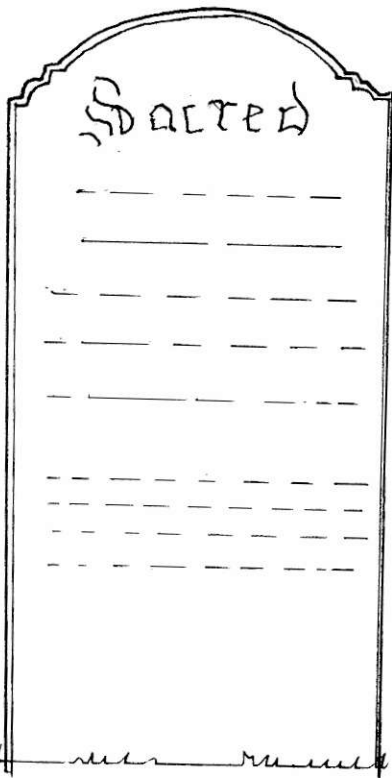

Sacred
 to the Memory of
 JOSEPH HOAR
 who departed this life
 the 15th day of July 1828
 in the 75th Year of his age

There are 4 lines of verse, illegible.
 HOAR sic

Grave Memorial Recording Form: St. John the Baptist, Westbourne, W. Sussex

1	National Grid Reference	755 073	Date	3	0	0	5	0	0
2	Name of recorder(s)	JOSEPHINE HALLETT							
3	Record No. of memorial (plus components i,ii,iii etc.)	N	E	B			1	7	2
4	No. of components or inscribed faces (record on reverse if possible)								
5	Type of memorial: 1 = flat 2 = head 3 = tomb 4 = foot 5 = tablet 6 = other								
6	Material and geology	LIMESTONE							
7	Stone mason or undertaker	NONE FOUND							
8	Which surfaces inscribed (facing N, S, E or W)								
9	No. of people commemorated								
10	Condition of monument: 1=sound 2=displaced 3=leaning 4=collapsed 5=damaged								
11	Technique of inscription: 1 = Incised 2 = carved in relief 3 = cast in relief 4 = lead letters 5 = painted	tracer of black in-filling							
12	Condition of inscription 1 = very good 2 = clear 3 = worn but decipherable 4 = partly legible 5 = illegible								
13	Dimensions (metric)	height	1	1	7	0			
		width		9	7	0			
		Thickness (or length in case of tombs)			7	0			
14	Date of memorial	1829*	Register John Miller, Hermitage, Joyce Miller, Hermitage, bu. 30 Jan. 1838, a. 88 // bu. 27 Dec. 1829, a. 83						
Drawing or Photograph					Inscription				

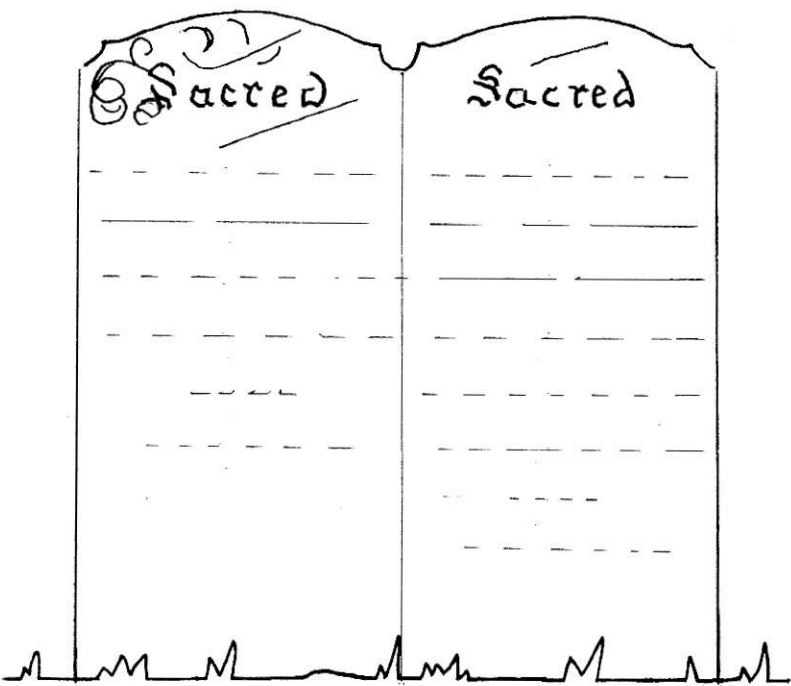

<p><i>Sacred</i></p> <p>To the Memory of</p> <p>JOHN MILLER</p> <p>who departed this life</p> <p>the 22nd day of December</p> <p>1829</p> <p>aged 83 Years</p>	<p><i>Sacred</i></p> <p>To the Memory of</p> <p>JOICE the Wife of</p> <p>JOHN MILLER</p> <p>who departed this life</p> <p>the 27th day of January</p> <p>1838</p> <p>aged 88 Years</p>
---	---

Grave Memorial Recording Form: St. John the Baptist, Westbourne, W. Sussex

1	National Grid Reference	755 073	Date	3	0	0	5	0	0	
2	Name of recorder(s)	JOHN LAMPLUGH								
3	Record No. of memorial (plus components i,ii,iii etc.)	N E B		1		7		3		
4	No. of components or inscribed faces (record on reverse if possible)									
5	Type of memorial: 1 = flat 2 = head 3 = tomb 4 = foot 5 = tablet 6 = other	2								
6	Material and geology	LIMESTONE								
7	Stone mason or undertaker	NONE FOUND								
8	Which surfaces inscribed (facing N, S, E or W)								W	
9	No. of people commemorated	2								
10	Condition of monument: 1=sound 2=displaced 3=leaning 4=collapsed 5=damaged								3	
11	Technique of inscription: 1 = incised 2 = carved in relief 3 = cast in relief 4 = lead letters 5 = painted								1	
12	Condition of inscription 1 = very good 2 = clear 3 = worn but decipherable 4 = partly legible 5 = illegible								3	
13	Dimensions (metric)	height	1	2	3	0	width	7	1	5
		Thickness (or length in case of tombs)			7	0				
14	Date of memorial	1782+	Register Sarah wife of John Hoare bu. 2 ^d Jan 1761 John Hoare bu. 18 July 1782							
Drawing or Photograph					Inscription					

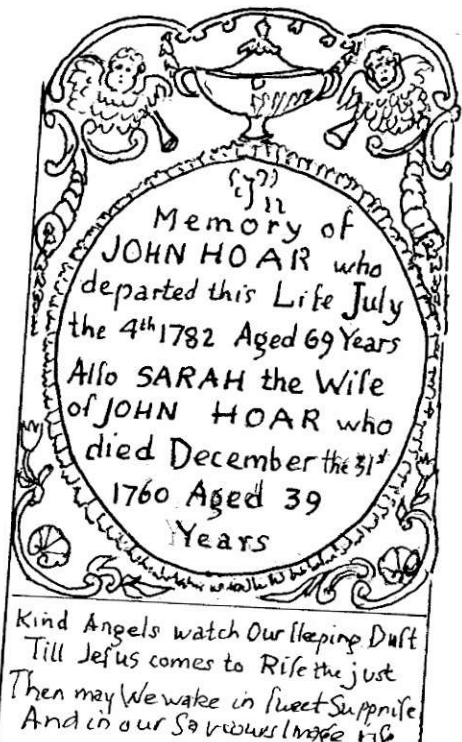



 Memory of
 JOHN HOAR who
 departed this Life July
 the 4th 1782 Aged 69 Years
 Also SARAH the Wife
 of JOHN HOAR who
 died December the 31st
 1760 Aged 39
 Years

Kind Angels watch Our Sleeping Dust
 Till Jesus comes to Rise the just
 Then may We wake in sweet Supprie
 And in our Saviour's Image rise

Grave Memorial Recording Form: St. John the Baptist, Westbourne, W. Sussex

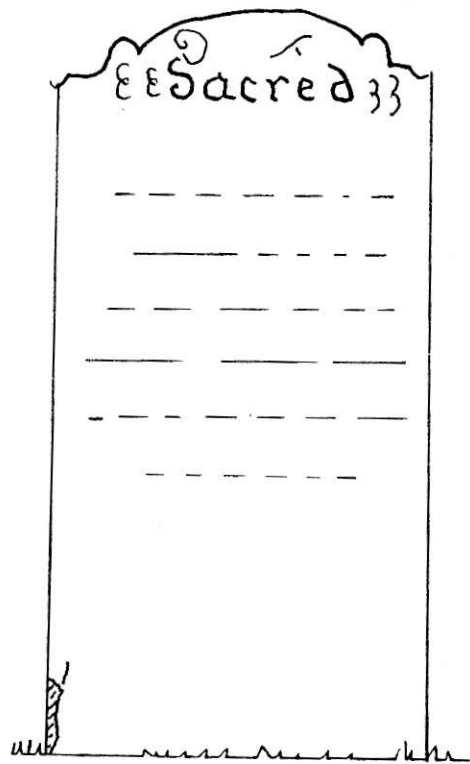
1	National Grid Reference	755 073	Date	0	6	0	6	0	0
2	Name of recorder(s)	JOSEPHINE HALLETT							
3	Record No. of memorial (plus components i,ii,iii etc.)	N E B		1 7 4					
4	No. of components or inscribed faces (record on reverse if possible)	1							
5	Type of memorial: 1 = flat 2 = head 3 = tomb 4 = foot 5 = tablet 6 = other	2							
6	Material and geology	LIMESTONE							
7	Stone mason or undertaker	NONE FOUND							
8	Which surfaces inscribed (facing N, S, E or W)								W
9	No. of people commemorated	1							
10	Condition of monument: 1=sound 2=displaced 3=leaning 4=collapsed 5=damaged								1
11	Technique of inscription: 1 = incised 2 = carved in relief 3 = cast in relief 4 = lead letters 5 = painted								1
12	Condition of inscription 1 = very good 2 = clear 3 = worn but decipherable 4 = partly legible 5 = illegible								4
13	Dimensions (metric)	height	4	8	0				
		width	6	9	0				
		Thickness (or length in case of tombs)		7	0				
14	Date of memorial	1826+	Register Mary Hoare, Printhead, b.u. 15 Sept. 1826						
Drawing or Photograph					Inscription				



{ { Sacred } }

to the Memory of

MARY. Wife of

WILLIAM HOARE

who departed this Life

the 13: of September 1[826]

Aged 67 Years

date supplied from Sperling + register

Grave Memorial Recording Form: St. John the Baptist, Westbourne, W. Sussex

1	National Grid Reference	755 073	Date	0	4	0	7	0	0
2	Name of recorder(s)	John Lamplugh							
3	Record No. of memorial (plus components i,ii,iii etc.)	N	E	B			1	7	5
4	No. of components or inscribed faces (record on reverse if possible)								
5	Type of memorial: 1 = flat 2 = head 3 = tomb 4 = foot 5 = tablet 6 = other	tomb over vault							
6	Material and geology	Limestone							
7	Stone mason or undertaker	none found							
8	Which surfaces inscribed (facing N, S, E or W)						N	S	
9	No. of people commemorated								
10	Condition of monument: 1=sound 2=displaced 3=leaning 4=collapsed 5=damaged								
11	Technique of inscription: 1 = incised 2 = carved in relief 3 = cast in relief 4 = lead letters 5 = painted								
12	Condition of inscription 1 = very good 2 = clear 3 = worn but decipherable 4 = partly legible 5 = illegible								
13	Dimensions (metric)	height		6	3	0			
		width	1	3	7	0			
		Thickness (or length in case of tombs)	2	4	2	0			
14	Date of memorial	1856+	Register Jane Oldfield, Hermitage,						
		John Oldfield, General K.H., Oldfield Lawn, bu. 8 Aug. 1863, a. 74 // bu May 13, 1856, a. 36							
		Radulphus Oldfield, Upper Clapton, bu. 12 Feb. 1877, a. 49							
		Elizabeth Mary Oldfield bu. 26 Oct. 1900, a. 89. Inscription							

[see over]

Note

Gen. John Oldfield is commemorated also in two commemorative gifts to the church: the new south porch (CW 412), and a window in the N wall of the chancel (NAO FAS 714). In those two inscriptions his date of death is given as August 2, 1863, not August 1st as on this tomb.

Jane and Elizabeth Mary are commemorated also in the chancel, CW 424

There is also a family vault of the Oldfields in Westbourne Cemetery, S side, where later members are commemorated.

[Jane Oldfield 1856
Gen. John Oldfield 1863
Cpt. Radulphus Oldfield 1877
Elizabeth Mary Oldfield 1900]

over

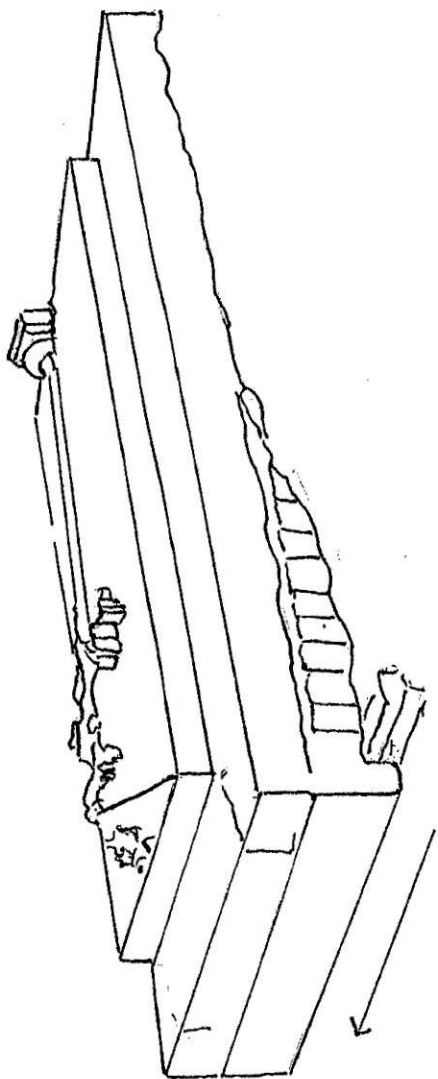

IN THIS VAULT ARE DEPOSITED THE MORTAL REMAINS OF
 GENERAL JOHN OLDFIELD KH COMMANDANT ROYAL ENGINEERS
 OF OLDFIELD LAWN WESTBURN SUSSEX
 BORN MAY 29, 1789 DIED AUGUST 1, 1863
 RADULPHUS BRYCE OLDFIELD CB CAPTAIN RA.
 [ADC] TO HER MAJESTY [4TH] SON OF GENL J OLDFIELD KH RE
 BORN JUNE 29 1827 DIED FEB 12TH 1877

JANE 2ND DAUGHTER OF GENL J OLDFIELD KH RE.
 BORN OCT 6 1819 DIED MAY 8TH 1856
 ELIZABETH MARY OLDFIELD ELDEST DAUGHTER OF
 GENERAL JOHN OLDFIELD KH COMMANDANT R.E.
 BORN DEC. 21 1810 DIED OCT 23, 1900

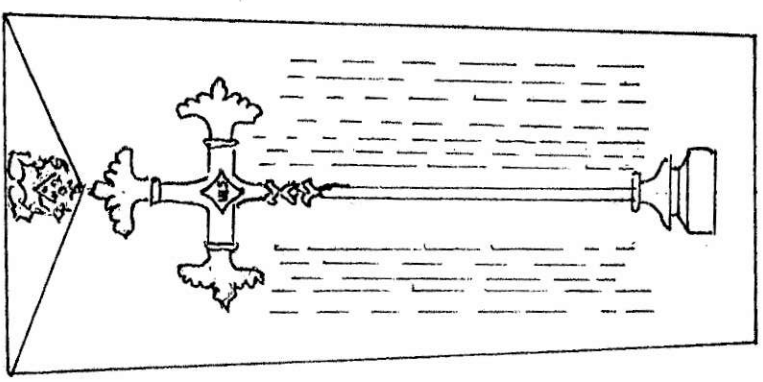

K.H. = Knight of the Royal Hanoverian Order, CB = Companion of the Bath
 Some dates and the A.D.C. appointment of Radulphus
 verified from Didfield Family History (H.O. 1936). Radulphus was the general's 4th surviving
 son.

To
 the Memory of
 WILLIAM GRUGGEN
 who died 20th of March
 1794
 Aged 54 Years

To
 the Memory of
 REBECCA the Wife of
 WILLIAM GRUGGEN
 who died 14th of April 1807
 Aged 63 Years

*Their flesh shall slumber in the ground
 Till the last trumpet [call] shall sound
 Then burst the Chains with sweet [sur]prise
 And in their Saviours Image arise*

Also of
 ROBERT GRUGGEN
 Son of the above
 who died 9th of December
 1830 Aged 64 Years

Grave Memorial Recording Form: St. John the Baptist, Westbourne, W. Sussex

1	National Grid Reference	755 673	Date	1	3	0	6	0	0
2	Name of recorder(s)	BERYL LINDER							
3	Record No. of memorial (plus components i,ii,iii etc.)	N	E	B			1	7	7
4	No. of components or inscribed faces (record on reverse if possible)								
5	Type of memorial: 1 = flat 2 = head 3 = tomb 4 = foot 5 = tablet 6 = other	2							
6	Material and geology	LIMESTONE							
7	Stone mason or undertaker	NONE FOUND							
8	Which surfaces inscribed (facing N, S, E or W)								W
9	No. of people commemorated	1							
10	Condition of monument: 1=sound 2=displaced 3=leaning 4=collapsed 5=damaged	3 1							
11	Technique of inscription: 1 = incised 2 = carved in relief 3 = cast in relief 4 = lead letters 5 = painted	1							
12	Condition of inscription 1 = very good 2 = clear 3 = worn but decipherable 4 = partly legible 5 = illegible	4							
13	Dimensions (metric)	height	1	2	4	0			
		width		6	5	0			
		Thickness (or length in case of tombs)			6	5			
14	Date of memorial	1834+	Register William Hoare Prunstead, 6th 5 May 1834 aged 79						
Drawing or Photograph					Inscription				

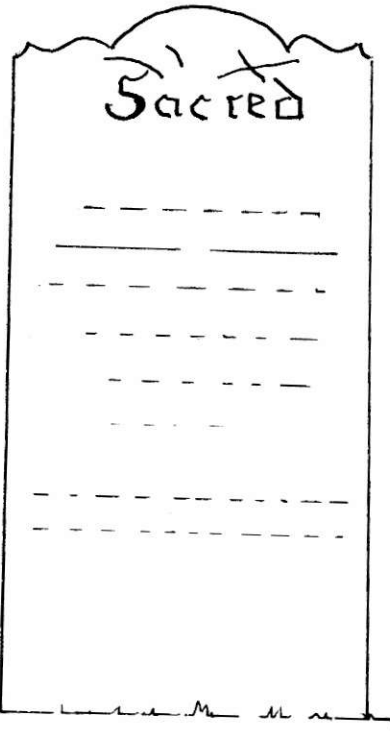

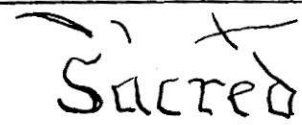
 Sacred

 to the Memory of
 WILLIAM HOARE
 who departed this Life
 the [4] of May 1834 *
 Aged 79 Years

could be 1st or 4th of May

Grave Memorial Recording Form: St. John the Baptist, Westbourne, W. Sussex

1	National Grid Reference	755 073	Date	1	3	0	6	0	0
2	Name of recorder(s)	BERYL LINDER							
3	Record No. of memorial (plus components i,ii,iii etc.)	N E B 1 7 8							
4	No. of components or inscribed faces (record on reverse if possible)	1							
5	Type of memorial: 1 = flat 2 = head 3 = tomb 4 = foot 5 = tablet 6 = other	2							
6	Material and geology	LIMESTONE: very layered and fossiliferous.							
7	Stone mason or undertaker	NONE FOUND							
8	Which surfaces inscribed (facing N, S, E or W)								W
9	No. of people commemorated	3							
10	Condition of monument: 1=sound 2=displaced 3=leaning 4=collapsed 5=damaged								3
11	Technique of inscription: 1 = incised 2 = carved in relief 3 = cast in relief 4 = lead letters 5 = painted								1
12	Condition of inscription 1 = very good 2 = clear 3 = worn but decipherable 4 = partly legible 5 = illegible								4
13	Dimensions (metric)	height	1	0	6	0			
		width		7	2	0			
		Thickness (or length in case of tombs)			6	5			
14	Date of memorial	1794+	Register	William not found (baptised 23 July 1788)					
	Mary d. of William & Elizabeth Hoar bu. 8 Sept. 1794 (baptised 11 Jan. 1792)								
	Ann not found, register for 1808 missing								
	Drawing or Photograph								Inscription

() ()

the Memory

Also ANN

() ()

the Memory
of two Children of
WILLIAM and ELIZABETH HOAR
WILLIAM died July [16] 1791
Aged [3] Years
MARY died Sep^r [] 1794 *
Aged 2 Years 10 Months

Also ANN Daughter of the above
who died December [27] 180[8]
Aged [11] Years

* Sperling gives Mary d. Sept. 22; register bu. 85
Ann d. Dec. 27th, a. 12

Grave Memorial Recording Form: St. John the Baptist, Westbourne, W. Sussex

1	National Grid Reference	755 073	Date	1	3	0	6	0	0	
2	Name of recorder(s)	VERONICA JAY								
3	Record No. of memorial (plus components i,ii,iii etc.)	N	E	B			1	7	9	
4	No. of components or inscribed faces (record on reverse if possible)									
5	Type of memorial: 1 = flat 2 = head 3 = tomb 4 = foot 5 = tablet 6 = other	2								
6	Material and geology	LIMESTONE								
7	Stone mason or undertaker	NONE FOUND								
8	Which surfaces inscribed (facing N, S, E or W)	W								
9	No. of people commemorated	1								
10	Condition of monument: 1=sound 2=displaced 3=leaning 4=collapsed 5=damaged	3								
11	Technique of inscription: 1 = incised 2 = carved in relief 3 = cast in relief 4 = lead letters 5 = painted	1								
12	Condition of inscription 1 = very good 2 = clear 3 = worn but decipherable 4 = partly legible 5 = illegible	3								
13	Dimensions (metric)	height	1	3	5	0	width	7	1	0
		Thickness (or length in case of tombs)			6	0				
14	Date of memorial	1799+	Register Elizabeth wife of William Hoare bu. 3 July 1799							
Drawing or Photograph					Inscription					

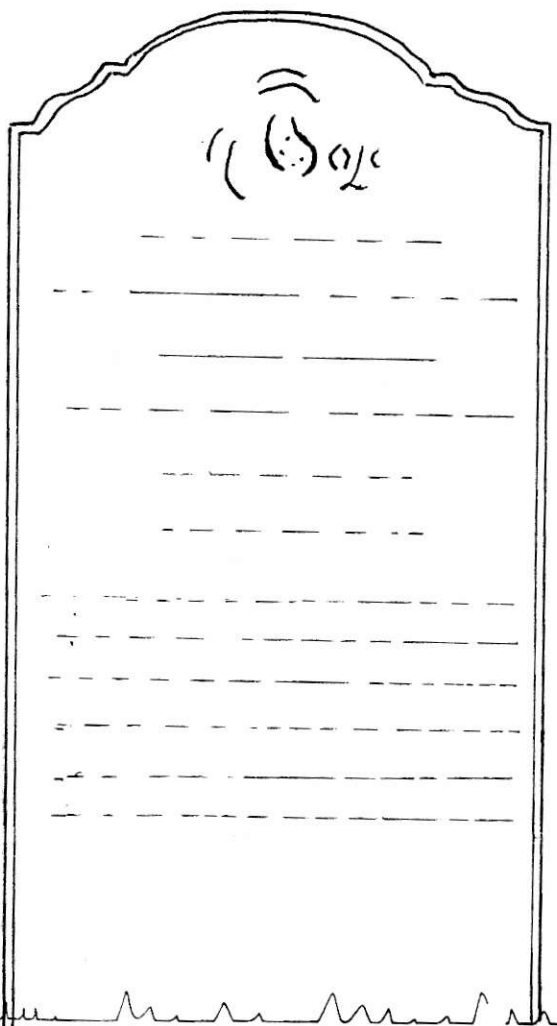



 the Memory
 of ELIZABETH Wife of
 WILLIAM HOAR
 who departed this Life
 June 30th 1799
 Aged 35 Years

Theres no Protection that can save
 Us Mortals from the silent Grave
 But all Mankind multy yield their Breath
 Unto the fatal stroke of Death
 In Love she lived in Faith she died
 Her Life was begg'd but was denied

Grave Memorial Recording Form: St. John the Baptist, Westbourne, W. Sussex

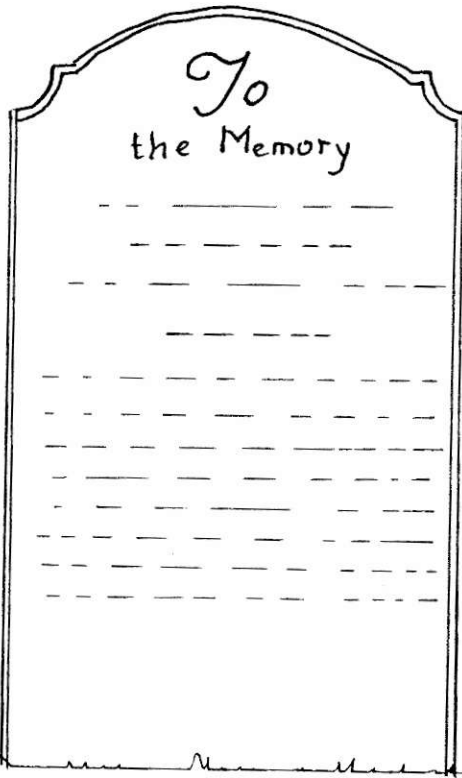
1	National Grid Reference	755 073	Date	1	3	0	6	0	0	
2	Name of recorder(s)	ANNA WILLIAMS								
3	Record No. of memorial (plus components i,ii,iii etc.)	N	E	B				1	8	0
4	No. of components or inscribed faces (record on reverse if possible)									1
5	Type of memorial: 1 = flat 2 = head 3 = tomb 4 = foot 5 = tablet 6 = other									2
6	Material and geology	LIMESTONE								
7	Stone mason or undertaker	NONE FOUND								
8	Which surfaces inscribed (facing N, S, E or W)									W
9	No. of people commemorated									1
10	Condition of monument: 1=sound 2=displaced 3=leaning 4=collapsed 5=damaged									3
11	Technique of inscription: 1 = incised 2 = carved in relief 3 = cast in relief 4 = lead letters 5 = painted									1
12	Condition of inscription 1 = very good 2 = clear 3 = worn but decipherable 4 = partly legible 5 = illegible									3
13	Dimensions (metric)	height	1	2	9	0				
		width		8	0	0				
		Thickness (or length in case of tombs)			8	0				
14	Date of memorial	1796+	Register Rebecca w. of Joseph Yalden bu. 22 Feb. 1796							
Drawing or Photograph		Inscription								



To
the Memory
of REBECCA Wife of
JOSEPH YALDEN
who died Feb^y 24 1796
Aged 45 Years

Adieu blest Woman Partner of my Life
A tender Mother and a faithful Wife
From Scandal free most ready to commend
Most loth to hurt, most proud to be a Friend
Her Partner's Comfort and his Life's Relief
Once his chief Joy but now his greatest Grief
Her God hath call'd her where shes sure to have
A Blifs more solid than herself once gave

discrepancy between dates in inscription
and register

Grave Memorial Recording Form: St. John the Baptist, Westbourne, W. Sussex

1	National Grid Reference	755 073	Date	2	0	0	6	0	0	
2	Name of recorder(s)	DAPHNE COOPER								
3	Record No. of memorial (plus components i,ii,iii etc.)	N	E	B			1	8	1	
4	No. of components or inscribed faces (record on reverse if possible)									
5	Type of memorial: 1 = flat 2 = head 3 = tomb 4 = foot 5 = tablet 6 = other	2								
6	Material and geology	LIMESTONE								
7	Stone mason or undertaker	NONE FOUND								
8	Which surfaces inscribed (facing N, S, E or W)	W								
9	No. of people commemorated	1								
10	Condition of monument: 1=sound 2=displaced 3=leaning 4=collapsed 5=damaged	1								
11	Technique of inscription: 1 = incised 2 = carved in relief 3 = cast in relief 4 = lead letters 5 = painted	1								
12	Condition of inscription 1 = very good 2 = clear 3 = worn but decipherable 4 = partly legible 5 = illegible	3								
13	Dimensions (metric)	height	1	2	7	0	width	8	0	0
		Thickness (or length in case of tombs)			7	5				
14	Date of memorial	1796 +	Register	Samuel Hoare bu. 29 Oct. 1796						

Drawing or Photograph

Inscription

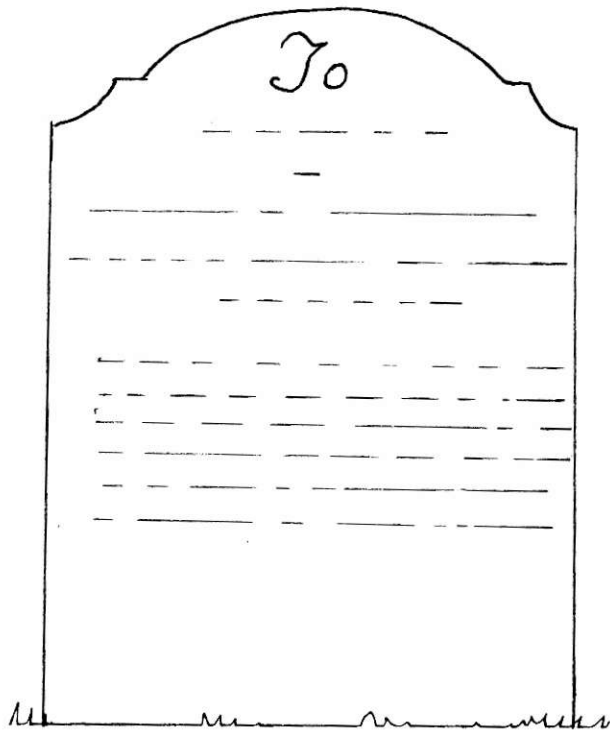

To
 the Memory
 of
 SAMUEL HOAR
 who died October 26 1796
 Aged 47 Years

Tho' Kindness labour'd to aſwage his Pain
 And Art had lent its ſoothing Aid in vain
 No impious murmur no indecent Strife.
 Mark'd the laſt moments of his uſeful Life
 Calmly reſign'd He left his cauſe to God
 And kiſſ'd with pious Lips the Friendly Roc

Grave Memorial Recording Form: St. John the Baptist, Westbourne, W. Sussex

1	National Grid Reference	755 073	Date	0	4	0	7	0	0
2	Name of recorder(s)	BERYL LINDER							
3	Record No. of memorial (plus components i,ii,iii etc.)	N	E	B			1	8	2
4	No. of components or inscribed faces (record on reverse if possible)								
5	Type of memorial: 1 = flat 2 = head 3 = tomb 4 = foot 5 = tablet 6 = other	2							
6	Material and geology	LIMESTONE							
7	Stone mason or undertaker	NONE FOUND							
8	Which surfaces inscribed (facing N, S, E or W)	fallen			N	A			
9	No. of people commemorated	probably							1
10	Condition of monument: 1=sound 2=displaced 3=leaning 4=collapsed 5=damaged	4 5							
11	Technique of inscription: 1 = incised 2 = carved in relief 3 = cast in relief 4 = lead letters 5 = painted								
12	Condition of inscription 1 = very good 2 = clear 3 = worn but decipherable 4 = partly legible 5 = illegible	3							
13	Dimensions (metric)	approx. height			1	1	0	0	
		width				7	6	0	
		Thickness (or length in case of tombs)			/	/	/	/	
14	Date of memorial	1817 +	Register John Overy, Prinstead, bu. 26 May 1817, a. 57						
Drawing or Photograph					Inscription				

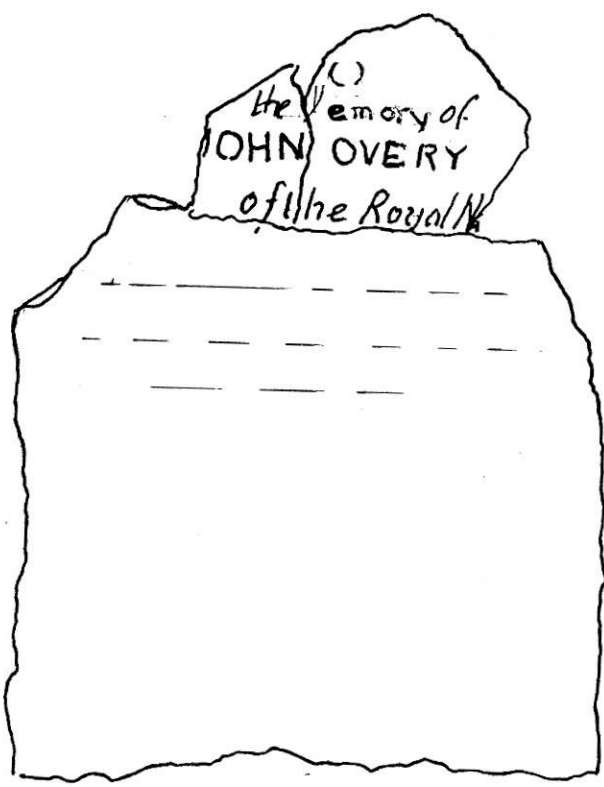

[T]o
 the [M]emory of
JOHN OVERY
 of the Royal Na[vy]
 who departed this life Suddenly
 on the 21 day of May 1817
 Aged 5[7] Years

Lying flat on ground

Grave Memorial Recording Form: St. John the Baptist, Westbourne, W. Sussex

1	National Grid Reference	Date	1	3	0	6	0	0	
2	Name of recorder(s)	PETER MERYON							
3	Record No. of memorial (plus components i,ii,iii etc.)	N	E	B	1	8	3		
4	No. of components or inscribed faces (record on reverse if possible)								1
5	Type of memorial: 1 = flat 2 = head 3 = tomb 4 = foot 5 = tablet 6 = other								2
6	Material and geology	LIMESTONE							
7	Stone mason or undertaker								
8	Which surfaces inscribed (facing N, S, E or W)								W
9	No. of people commemorated								3
10	Condition of monument: 1=sound 2=displaced 3=leaning 4=collapsed 5=damaged								1
11	Technique of inscription: 1 = incised 2 = carved in relief 3 = cast in relief 4 = lead letters 5 = painted								1
12	Condition of inscription 1 = very good 2 = clear 3 = worn but decipherable 4 = partly legible 5 = illegible								2
13	Dimensions (metric)	height	1	3	3	0			
		width		7	7	0			
		Thickness (or length in case of tombs)			6	5			
14	Date of memorial 1855 +	Register William a. 2, bu. Jan 3. 1851, of Woodmancot							
	John aged 46, bu. 4 Oct. 1855 //	John bu. 29 1856 a. 14 mths							
Drawing or Photograph				Inscription					

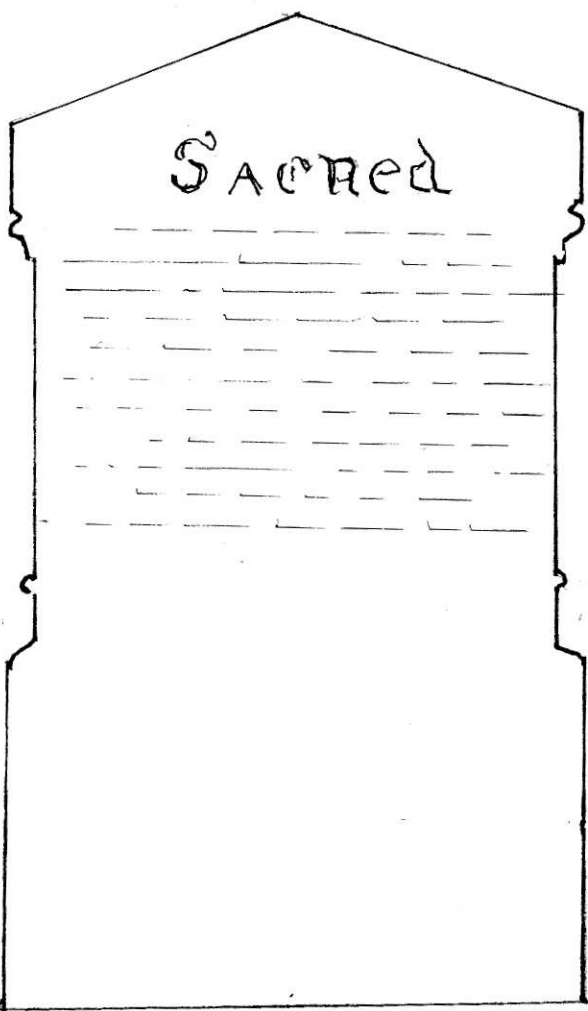



SACRED
 TO THE MEMORY OF
 JOHN AYLING SON OF
 WILLIAM AND ANN AYLING
 WHO DEPARTED THIS LIFE
 30TH SEPT 1855 AGED 46 YEARS.
 ALSO WILLIAM SON OF THE ABOVE
 WHO DEPARTED THIS LIFE 31ST DEC. 1850
 AGED 2 YEARS AND 3 MONTHS
 ALSO JOHN SON OF THE ABOVE
 WHO DEPARTED THIS LIFE
 23RD JAN^R 1856 AGED 14 MONTHS

* could be 5 mths
 ** could be 25 JAN.

Grave Memorial Recording Form: St. John the Baptist, Westbourne, W. Sussex

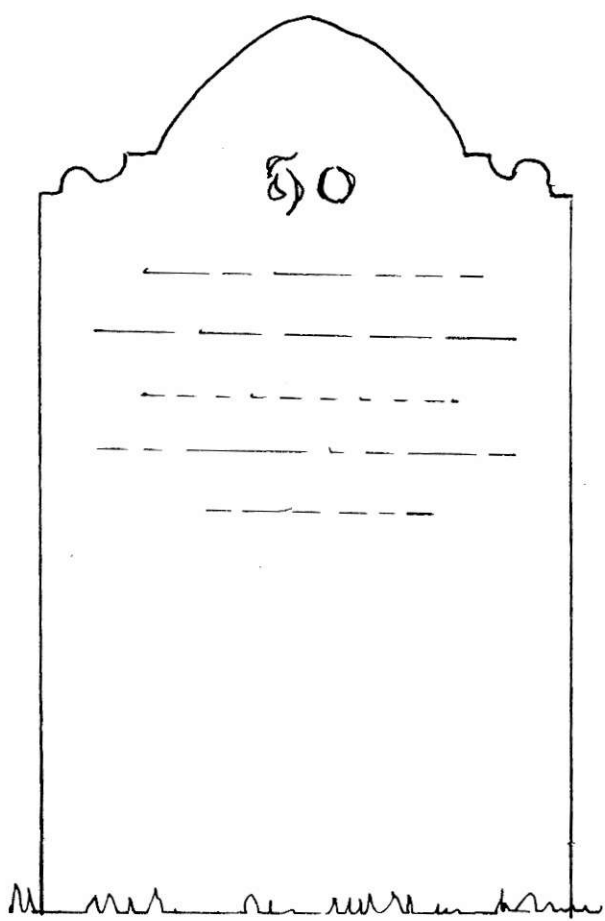
1	National Grid Reference	755 073	Date	2	0	0	6	0	0
2	Name of recorder(s)	DAPHNE MERYON							
3	Record No. of memorial (plus components i,ii,iii etc.)	N	E	3			1	8	4
4	No. of components or inscribed faces (record on reverse if possible)	1							
5	Type of memorial: 1 = flat 2 = head 3 = tomb 4 = foot 5 = tablet 6 = other	2							
6	Material and geology	STONE : limestone, Portland type							
7	Stone mason or undertaker	none found							
8	Which surfaces inscribed (facing N, S, E or W)								W
9	No. of people commemorated	1							
10	Condition of monument: 1=sound 2=displaced 3=leaning 4=collapsed 5=damaged	1							
11	Technique of inscription: 1 = incised 2 = carved in relief 3 = cast in relief 4 = lead letters 5 = painted	1							
12	Condition of inscription 1 = very good 2 = clear 3 = worn but decipherable 4 = partly legible 5 = illegible	4							
13	Dimensions (metric)	height	1	2	3	0			
		width		6	7	0			
		Thickness (or length in case of tombs)			7	0			
14	Date of memorial	1821+	Register Henry Marsh (Capt. R.N.) bur 19 Sept. 1821 a. 68, of Westbourne						
Drawing or Photograph					Inscription				





 the Memory of
 CAPT HENRY MARSH R.N.
 [who departed this life]
 the 14th September 1821
 Aged 68 years

Said to be brother of John Marsh the Chichester composer.

footstone in pavement at W end of nave, C 515.

Grave Memorial Recording Form: St. John the Baptist, Westbourne, W. Sussex

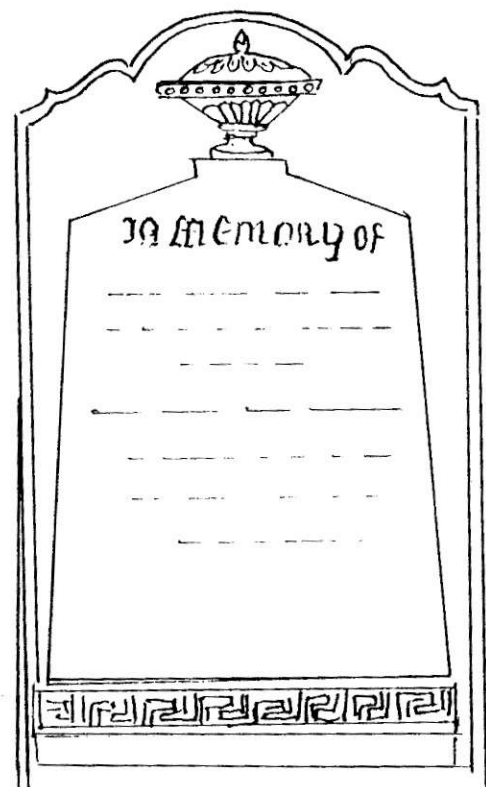
1	National Grid Reference 755 073	Date	2	0	0	6	0	0	
2	Name of recorder(s) DAPHNE COOPER								
3	Record No. of memorial (plus components i,ii,iii etc.)	N	E	B			1	8	5
4	No. of components or inscribed faces (record on reverse if possible)								1
5	Type of memorial: 1 = flat 2 = head 3 = tomb 4 = foot 5 = tablet 6 = other								2
6	Material and geology LIMESTONE: PORTLAND/PURBECK TYPE								
7	Stone mason or undertaker NONE FOUND								
8	Which surfaces inscribed (facing N, S, E or W)								W
9	No. of people commemorated								2
10	Condition of monument: 1=sound 2=displaced 3=leaning 4=collapsed 5=damaged								1
11	Technique of inscription: 1 = incised 2 = carved in relief 3 = cast in relief 4 = lead letters 5 = painted								1
12	Condition of inscription 1 = very good 2 = clear 3 = worn but decipherable 4 = partly legible 5 = illegible								2
13	Dimensions (metric)	height	1	5	4	0			
		width		7	5	0			
		Thickness (or length in case of tombs)			6	7			
14	Date of memorial 1830+	Register Elizabeth Wilkes, Havant							
	George Augustus Wilkes, Portsea, bu. 11 Feb. 1831 a. 74		//bu. 23 Sept. 1830 a. 70						
Drawing or Photograph					Inscription				



IN MEMORY OF
 ELIZABETH WILKES
 died September 19th 1830
 Aged 70 Years
 GEORGE AUGUSTUS WILKES
 Husband of the above
 died February 7th 1831
 Aged 74 Years

William A. M. M. M. M. M.

Grave Memorial Recording Form: St. John the Baptist, Westbourne, W. Sussex

1	National Grid Reference	755 073	Date	2	0	0	6	0	0
2	Name of recorder(s)	BEAYL LINDER							
3	Record No. of memorial (plus components i,ii,iii etc.)	N E B 1 8 6							
4	No. of components or inscribed faces (record on reverse if possible)	1							
5	Type of memorial: 1 = flat 2 = head 3 = tomb 4 = foot 5 = tablet 6 = other	tomb over vault 3							
6	Material and geology	LIMESTONE							
7	Stone mason or undertaker	NONE FOUND							
8	Which surfaces inscribed (facing N, S, E or W)	E							
9	No. of people commemorated	2							
10	Condition of monument: 1=sound 2=displaced 3=leaning 4=collapsed 5=damaged	1							
11	Technique of inscription: 1 = incised 2 = carved in relief 3 = cast in relief 4 = lead letters 5 = painted	1							
12	Condition of inscription 1 = very good 2 = clear 3 = worn but decipherable 4 = partly legible 5 = illegible	4							
13	Dimensions (metric)	max. including plinth		height					
				width	4	3	0		
				Thickness (or length in case of tombs)	1	8	5	0	
14	Date of memorial	1842	Register						
Rev. Travers Arthur Golding, Curate, of Westbourne Vicarage, bu. 5 Sept. 1842 age 30. Alice Letitia Newland, Bognor, bu. Feb. 1894 aged 68									
Drawing or Photograph					Inscription				

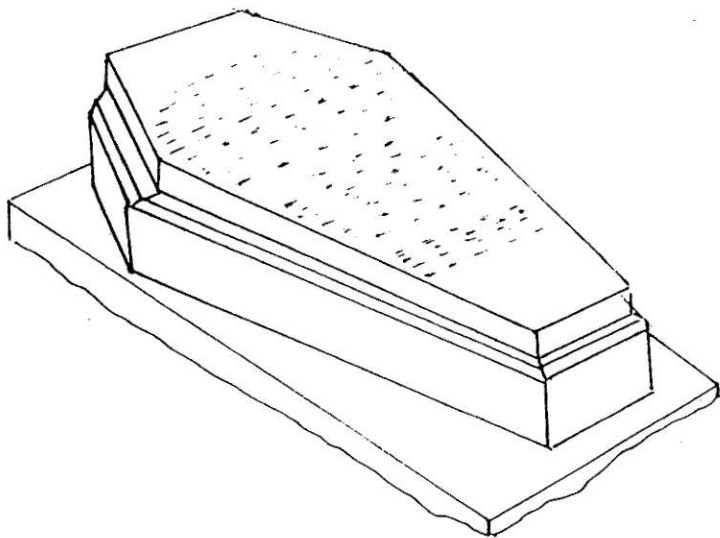

BENEATH
 LIE THE REMAINS OF THE
 REV. TRAVERS ARTHUR GOLDING
 CURATE OF THIS PARISH
 AND THIRD SON OF
 GEORGE RICHARD GOLDING ESQ.
 OF LIME PARK LODGE
 COUNTY TYRONE IRELAND
 BORN JULY [3] 181[2]
 DIED SEPT 2 1842

ALSO OF
 ALICIA LETITIA WIFE OF
 CAPTAIN C.F. NEWLAND RN.
 THIRD DAUGHTER OF
 GENERAL JOHN OLDFIELD K.H.R.E.
 BORN ATHLONE AUGUST 10TH 1825
 DIED BOGNOR JANUARY 28TH 189[4]

TEACH ME TO DO THE THING THAT PLEAS
 ETH THEE. FOR THOU ART MY GOD LET
 THY LOVING SPIRIT LEAD ME FORTH
 INTO THE LAND OF RIGHT EOUSNESS

Grave Memorial Recording Form: St. John the Baptist, Westbourne, W. Sussex

1	National Grid Reference	755 073	Date	0	9	0	5	0	0
2	Name of recorder(s)	PETER MERYON							
3	Record No. of memorial (plus components i,ii,iii etc.)	N E B				1 8 7			
4	No. of components or inscribed faces (record on reverse if possible)	1							
5	Type of memorial: 1 = flat 2 = head 3 = tomb 4 = foot 5 = tablet 6 = other	2							
6	Material and geology	LIMESTONE							
7	Stone mason or undertaker	NONE FOUND							
8	Which surfaces inscribed (facing N, S, E or W)								W
9	No. of people commemorated	4							
10	Condition of monument: 1=sound 2=displaced 3=leaning 4=collapsed 5=damaged								1
11	Technique of inscription: 1 = incised 2 = carved in relief 3 = cast in relief 4 = lead letters 5 = painted								1
12	Condition of inscription 1 = very good 2 = clear 3 = worn but decipherable 4 = partly legible 5 = illegible								3
13	Dimensions (metric)	height	1	3	8	0			
		width		6	7	0			
		Thickness (or length in case of tombs)			7	0			
14	Date of memorial	1852+	Register William Bridger Morgan, Westbourne, a. 1						
	bu. 17 May 1849 // Georgiana Morgan of Westbourne a. 26, bu. 23 March 1851 // William Morgan of Westbourne								
	aged 28 bu. 20 March 1852 // Elizabeth Eliza Sarah Anne Morgan (Wbourne) bu. Dec. 1 1854, a. 4 yrs.								
	bapt. Apr. 28 1850, d. of W. 96 Georgiana Morgan, blacksmith								

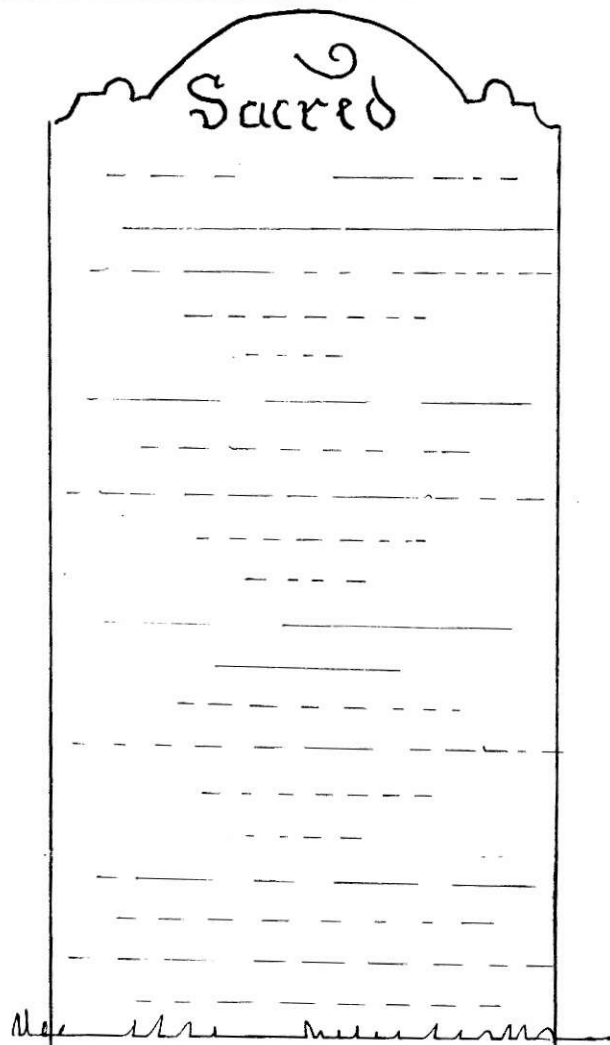

Sacred

to the Memory of
WILLIAM MORGAN
 who died the 13th of March 1852
 Aged 28 Years
 Also
GEORGIANA MORGAN
 Wife of the above
 who died the 16th of March 1851
 Aged 26 Years
 Also
**WILLIAM BRIDGER
 MORGAN**
 Son of the above
 who died the 13th of May 1849
 Aged 2 Years
 Also
ELIZABETH ELIZA
 Daughter of the above
 who died the 25th of November 1854
 Aged 4 Years and 8 months *

* could be 6 months

Grave Memorial Recording Form: St. John the Baptist, Westbourne, W. Sussex

1	National Grid Reference	755 073	Date	0	9	0	5	0	0	
2	Name of recorder(s)	KEITH LINDER								
3	Record No. of memorial (plus components i,ii,iii etc.)	N	E	B				1	8	8
4	No. of components or inscribed faces (record on reverse if possible)									1
5	Type of memorial: 1 = flat 2 = head 3 = tomb 4 = foot 5 = tablet 6 = other									2
6	Material and geology	STONE: LIMESTONE								
7	Stone mason or undertaker	NONE FOUND								
8	Which surfaces inscribed (facing N, S, E or W)									W
9	No. of people commemorated									2
10	Condition of monument: 1=sound 2=displaced 3=leaning 4=collapsed 5=damaged									3
11	Technique of inscription: 1 = incised 2 = carved in relief 3 = cast in relief 4 = lead letters 5 = painted									1
12	Condition of inscription 1 = very good 2 = clear 3 = worn but decipherable 4 = partly legible 5 = illegible									
13	Dimensions (metric)			height	1	0	3	0		
				width		6	0	0		
				Thickness (or length in case of tombs)			7	5		
14	Date of memorial	1805 +	Register Martha wife of Charles Leggett bu. 1 Dec 1805 Charles son of Charles & Martha Leggett bu. 16 Dec. 1805							
Drawing or Photograph					Inscription					

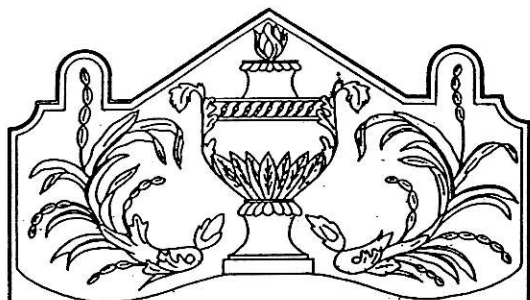

To
 the Memory
 of MARTHA Wife of
 CHARLES LEGGATT
 who died November 23 1805
 Aged 28 Years
 CHARLES Son of
 the above
 who died December 8th 1805

To
 the Memory
 of MARTHA Wife of
 CHARLES LEGGATT
 who died November 23 1805
 Aged 28 Years
 CHARLES Son of
 the above
 who died December 8th 1805
 Aged 1 Year and 11 Months

Grave Memorial Recording Form: St. John the Baptist, Westbourne, W. Sussex

1	National Grid Reference	755 073	Date	2	7	0	6	0	0
2	Name of recorder(s)	JOSEPHINE HALLETT							
3	Record No. of memorial (plus components i,ii,iii etc.)	N E B		1 8 9					
4	No. of components or inscribed faces (record on reverse if possible)	1							
5	Type of memorial: 1 = flat 2 = head 3 = tomb 4 = foot 5 = tablet 6 = other	2							
6	Material and geology	LIMESTONE							
7	Stone mason or undertaker	NONE FOUND							
8	Which surfaces inscribed (facing N, S, E or W)								W
9	No. of people commemorated	2							
10	Condition of monument: 1=sound 2=displaced 3=leaning 4=collapsed 5=damaged								1
11	Technique of inscription: 1 = incised 2 = carved in relief 3 = cast in relief 4 = lead letters 5 = painted								5 1
12	Condition of inscription 1 = very good 2 = clear 3 = worn but decipherable 4 = partly legible 5 = illegible								3
13	Dimensions (metric)	height	1	2	5	5			
		width		7	1	5			
		Thickness (or length in case of tombs)			6	5			
14	Date of memorial	1839+	Register	Daniel Morgan, Westbourne					
		Sarah Morgan, Thorney, bu. 6 Dec 1846 a. 79		bu. 4 August 1839 a. 67					
Drawing or Photograph					Inscription				

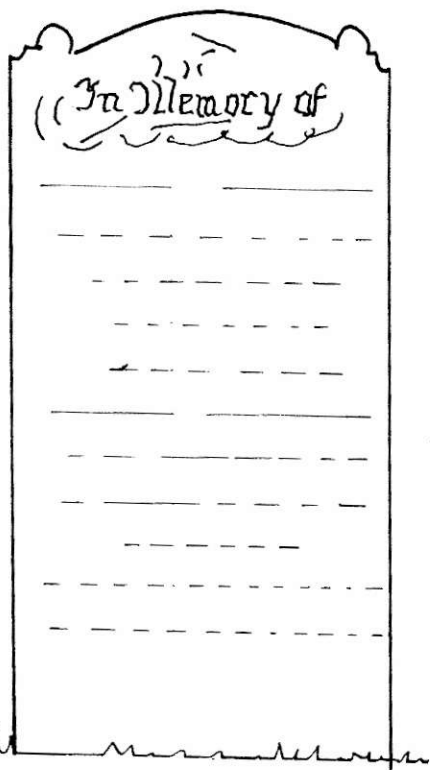

In Memory of
DANIEL MORGAN
 who Departed this Life
 the 28th of July 1839
 Aged 68 Years.
 Also his Wife
SARAH MORGAN
 who Departed this Life
 the 30th of November 1846
 Aged 78 Years.

For as in Adam all die even so in
 Christ shall all be made alive

I Corinthians cXV v.XXII

Grave Memorial Recording Form: St. John the Baptist, Westbourne, W. Sussex

1	National Grid Reference	755 073	Date	2	7	0	6	0	0
2	Name of recorder(s)	BERYL LINDER							
3	Record No. of memorial (plus components I,ii,iii etc.)	N E B 1 9 0							
4	No. of components or inscribed faces (record on reverse if possible)	1							
5	Type of memorial: 1 = flat 2 = head 3 = tomb 4 = foot 5 = tablet 6 = other	3							
6	Material and geology	L I M E S T O N E							
7	Stone mason or undertaker	NONE FOUND							
8	Which surfaces inscribed (facing N, S, E or W)	E							
9	No. of people commemorated	3							
10	Condition of monument: 1=sound 2=displaced 3=leaning 4=collapsed 5=damaged	1							
11	Technique of inscription: 1 = incised 2 = carved in relief 3 = cast in relief 4 = lead letters 5 = painted	1							
12	Condition of inscription 1 = very good 2 = clear 3 = worn but decipherable 4 = partly legible 5 = illegible	4							
13	Dimensions (metric)	Plinth	height	3	0	0			
			width	7	7	0			
		Thickness (or length in case of tombs)	1	8	8	0			
14	Date of memorial	1839+	Register	John Palmer W.B. bw 8Nw1639					
		Harriet Palmer W.B. bw 17 July 1843 age 37 //		age 41					
		Infant not found.							
	Drawing or Photograph	Inscription							

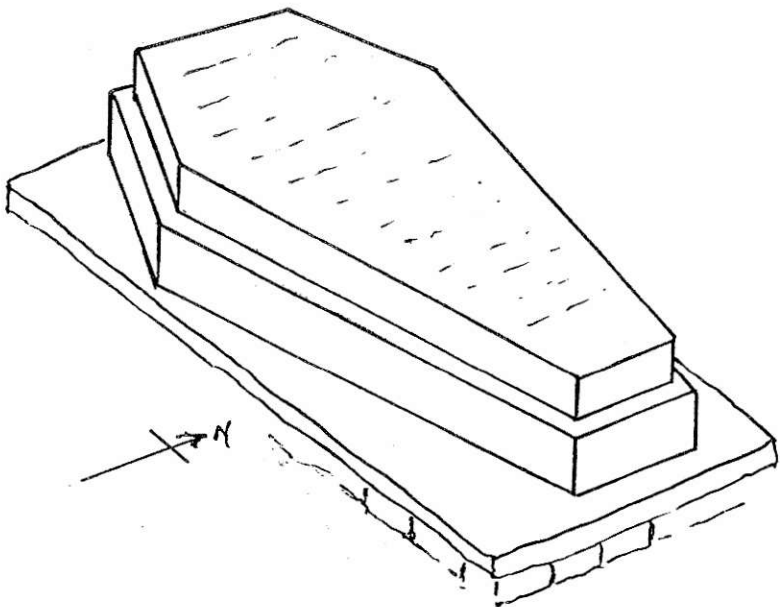

HERE ARE DEPOSITED
 THE REMAINS
 OF
 JOHN PALMER
 FORMERLY 2 LEIUTENANT
 * IN [2 11] CEYLON
 REGIMENT
 BORN [] APRIL 1798
 DIED [3] NOVEMBER 1839

ALSO
 THE INFANT SON OF THE ABOVE
 MAURICE CHARLES PALMER
 WHO DEPARTED THIS LIFE
 THE 23RD OF FEBRUARY 18[41]
 AGED 18 MONTHS
 ALSO HARRIET WIFE
 OF THE ABOVE WHO DIED
 THE 10TH OF JULY 1843
 AGED 37 YEARS

LEIUTENANT sic
 Days of John Palmer's birth & death are illegible; Sperling gives March (incorrect) & no day for birth; 3rd Nov. for death.

* Sperling and the Army lists both say 2nd Ceylon Regiment

Grave Memorial Recording Form: St. John the Baptist, Westbourne, W. Sussex

1 National Grid Reference	755 073	Date	2	8	0	6	0	0
2 Name of recorder(s)	DAPHNE COOPER							
3 Record No. of memorial (plus components i,ii,iii etc.)	N E B		1		9		1	
4 No. of components or inscribed faces (record on reverse if possible)	1							
5 Type of memorial: 1 = flat 2 = head 3 = tomb 4 = foot 5 = tablet 6 = other	2							
6 Material and geology	LIMESTONE							
7 Stone mason or undertaker	NONE FOUND							
8 Which surfaces inscribed (facing N, S, E or W)								W
9 No. of people commemorated	1							
10 Condition of monument: 1=sound 2=displaced 3=leaning 4=collapsed 5=damaged	3							1
11 Technique of inscription: 1 = incised 2 = carved in relief 3 = cast in relief 4 = lead letters 5 = painted								1
12 Condition of inscription 1 = very good 2 = clear 3 = worn but decipherable 4 = partly legible 5 = illegible								3
13 Dimensions (metric)	height	1	0	8	5			
	width		7	1	0			
	Thickness (or length in case of tombs)			6	5			
14 Date of memorial	1849+	Register	Henry Lowe bu. Nov. 29 1849					
aged 47. Westbourne								
Drawing or Photograph					Inscription			

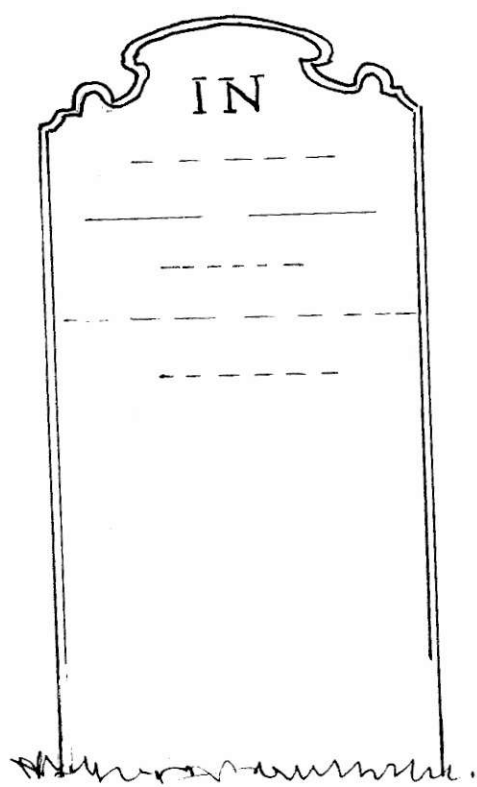

IN
 MEMORY OF
 HENRY LOWE
 WHO DIED
 THE 24TH OF NOVEMBER 1849
 AGED 47 YEARS.

Footstone no. NW 93

Grave Memorial Recording Form: St. John the Baptist, Westbourne, W. Sussex

1	National Grid Reference	755 073	Date	2	7	0	6	0	0
2	Name of recorder(s)	June Marshall							
3	Record No. of memorial (plus components i,ii,iii etc.)	N E B 1 9 2							
4	No. of components or inscribed faces (record on reverse if possible)	1							
5	Type of memorial: 1 = flat 2 = head 3 = tomb 4 = foot 5 = tablet 6 = other	2							
6	Material and geology	Limestone							
7	Stone mason or undertaker	HUNT [place not found]							
8	Which surfaces inscribed (facing N, S, E or W)	W							
9	No. of people commemorated	2							
10	Condition of monument: 1=sound 2=displaced 3=leaning 4=collapsed 5=damaged	1							
11	Technique of inscription: 1 = incised 2 = carved in relief 3 = cast in relief 4 = lead letters 5 = painted	1							
12	Condition of inscription 1 = very good 2 = clear 3 = worn but decipherable 4 = partly legible 5 = illegible	2							
13	Dimensions (metric)	height	1	3	3	5			
		width		7	4	0			
		Thickness (or length in case of tombs)			6	5			
14	Date of memorial	1828+	Register Robert Webb, Westbourne, bu.						
		Mary Webb, Westbourne, bu.	13 March, 1836, a. 68//		14 Jan. 1828, a. 60				
Drawing or Photograph					Inscription				

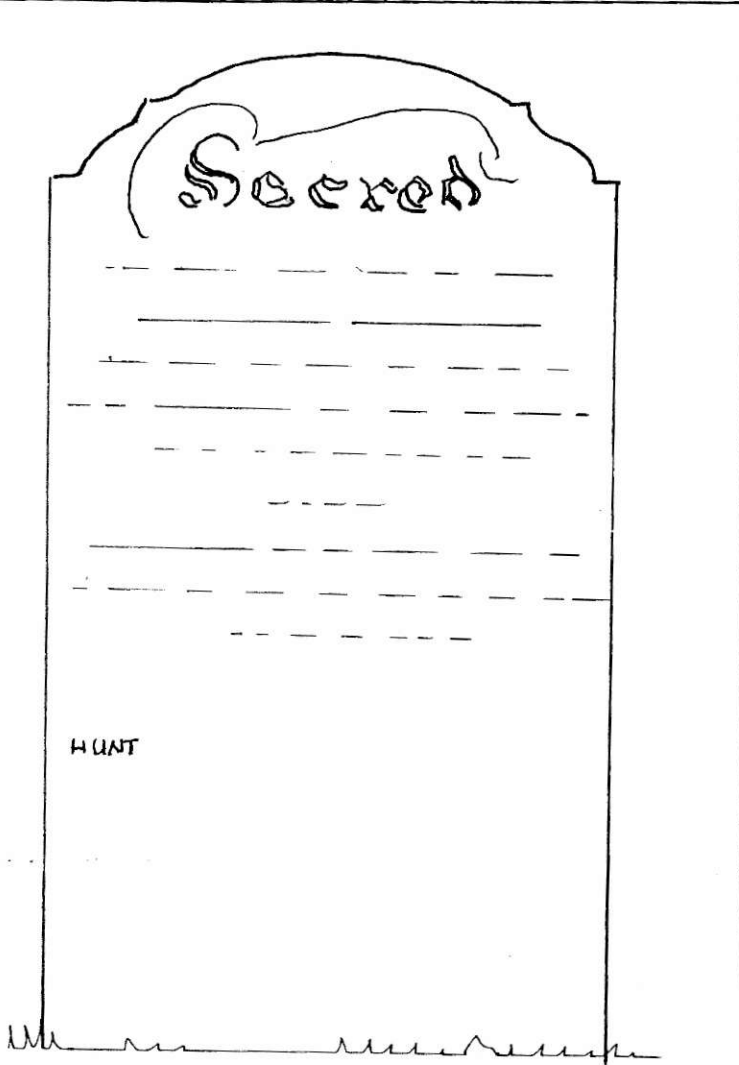

Sacred

To the Memory of
ROBERT WEBB
 who departed this Life
 the 6th day of January 1828
 in the 60th Year of his age
 Also
MARY. Wife of the above who
 died March the 7th 1836
 Aged 68 Years

Grave Memorial Recording Form: St. John the Baptist, Westbourne, W. Sussex

1	National Grid Reference	755 073	Date	2	7	0	6	0	0
2	Name of recorder(s)	DAPHNE COOPER							
3	Record No. of memorial (plus components i,ii,iii etc.)	N	E	B			1	9	3
4	No. of components or inscribed faces (record on reverse if possible)								
5	Type of memorial: 1 = flat 2 = head 3 = tomb 4 = foot 5 = tablet 6 = other	2							
6	Material and geology	LIMESTONE							
7	Stone mason or undertaker	NONE FOUND							
8	Which surfaces inscribed (facing N, S, E or W)	W							
9	No. of people commemorated	1							
10	Condition of monument: 1=sound 2=displaced 3=leaning 4=collapsed 5=damaged	Surface eroded 5							
11	Technique of inscription: 1 = incised 2 = carved in relief 3 = cast in relief 4 = lead letters 5 = painted	1							
12	Condition of inscription 1 = very good 2 = clear 3 = worn but decipherable 4 = partly legible 5 = illegible	5							
13	Dimensions (metric)	height	9	6	5	width	6	4	0
		Thickness (or length in case of tombs)		8	0				
14	Date of memorial prob. last $\frac{1}{4}$ of 18c.	Register							

Drawing or Photograph

Inscription



[none remains]

Comparison with somewhat similar iconography on nos. NEB 166 (1777), NEB 167 (1775 or 1775) & SH 38 (1783) suggests a date in the last quarter of the 18c.

Grave Memorial Recording Form: St. John the Baptist, Westbourne, W. Sussex

1	National Grid Reference	755 073	Date	1	1	0	7	0	0
2	Name of recorder(s)	DAPHNE COOPER							
3	Record No. of memorial (plus components i,ii,iii etc.)	N E B 1 9 4							
4	No. of components or inscribed faces (record on reverse if possible)	1							
5	Type of memorial: 1 = flat 2 = head 3 = tomb 4 = foot 5 = tablet 6 = other	2							
6	Material and geology	LIMESTONE							
7	Stone mason or undertaker	NONE FOUND							
8	Which surfaces inscribed (facing N, S, E or W)								W
9	No. of people commemorated	1							
10	Condition of monument: 1=sound 2=displaced 3=leaning 4=collapsed 5=damaged	1 3							
11	Technique of inscription: 1 = incised 2 = carved in relief 3 = cast in relief 4 = lead letters 5 = painted	1							
12	Condition of inscription 1 = very good 2 = clear 3 = worn but decipherable 4 = partly legible 5 = illegible	3							
13	Dimensions (metric)	height	1	6	6	0			
		width		7	4	5			
		Thickness (or length in case of tombs)		1	0	0			
14	Date of memorial	1847+	Register John O'Brien of Westbourne a-28 bu. 1 st July 1847						
Drawing or Photograph					Inscription				

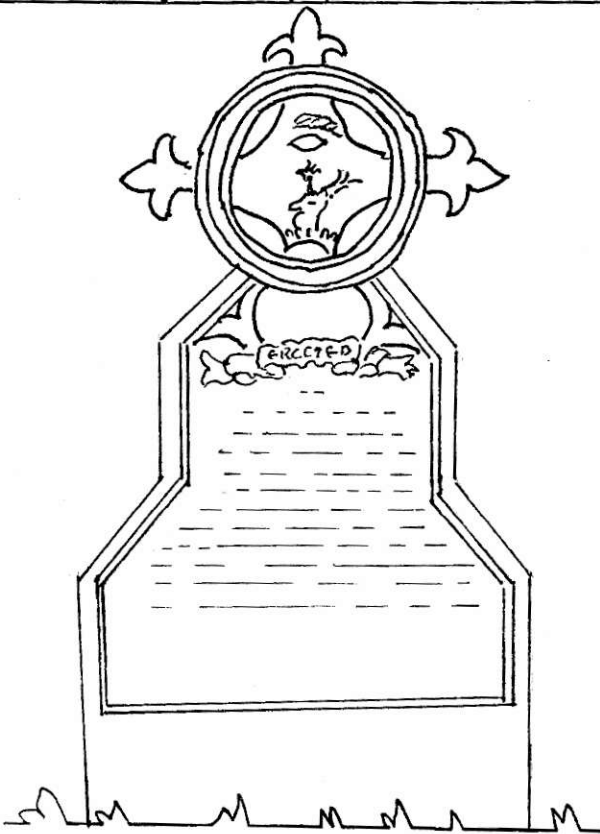

[See over:
John O'Brien, 1847]

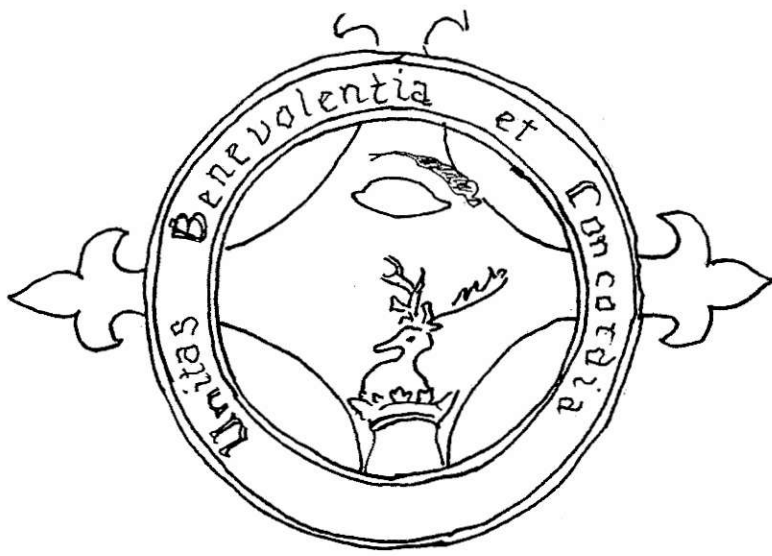

By the

Portsmouth District of the
Ancient Order of Foresters
as a mark of respect to the

memory of

John O'BRIEN P.C.R.

of Court 1850 Westbourne

who by his zeal and exertions in

carrying out the objects of the Order
contributed to the successful establishment

of forestry in Portsmouth

he died June 26th 1847 Aged 27 Years

motto: Unity, Benevolence and Concord

p. c. R - past chief Ranger

Grave Memorial Recording Form: St. John the Baptist, Westbourne, W. Sussex

1	National Grid Reference	755 073	Date	0	4	0	7	0	0
2	Name of recorder(s)	OHARE P.J.							
3	Record No. of memorial (plus components i,ii,iii etc.)	N E B 1 9 5							
4	No. of components or inscribed faces (record on reverse if possible)	1							
5	Type of memorial: 1 = flat 2 = head 3 = tomb 4 = foot 5 = tablet 6 = other	2							
6	Material and geology	LIMESTONE							
7	Stone mason or undertaker	NONE FOUND							
8	Which surfaces inscribed (facing N, S, E or W)	W							
9	No. of people commemorated	1							
10	Condition of monument: 1=sound 2=displaced 3=leaning 4=collapsed 5=damaged	1							
11	Technique of inscription: 1 = incised 2 = carved in relief 3 = cast in relief 4 = lead letters 5 = painted	1							
12	Condition of inscription 1 = very good 2 = clear 3 = worn but decipherable 4 = partly legible 5 = illegible	3							
13	Dimensions (metric)	height	1	1	0	0			
		width	0	6	9	0			
		Thickness (or length in case of tombs)	0	0	7	0			
14	Date of memorial	1853+	Register	not found					
Drawing or Photograph		Inscription							

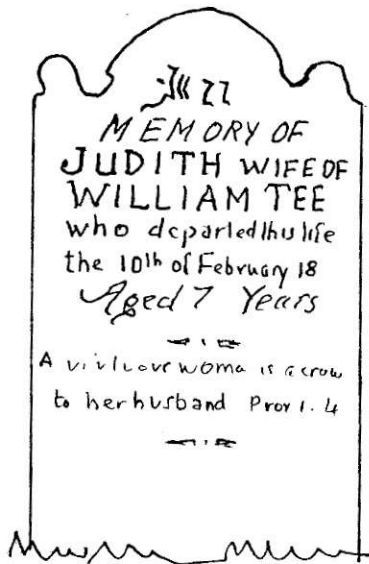

MEMORY OF
 JUDITH WIFE OF
 WILLIAM TEE
 who departed this life
 the 10th of February 1853
 Aged 7½ Years
 A virtuous woman is a crown
 to her husband Prov. 12.4

Grave Memorial Recording Form: St. John the Baptist, Westbourne, W. Sussex

1	National Grid Reference	755 073	Date	1	1	0	7	0	0
2	Name of recorder(s)	O'HARE P.J.							
3	Record No. of memorial (plus components i,ii,iii etc.)	N E B		1		9		6	
4	No. of components or inscribed faces (record on reverse if possible)	1							
5	Type of memorial: 1 = flat 2 = head 3 = tomb 4 = foot 5 = tablet 6 = other	3							
6	Material and geology	BRICK BASE WITH SLATE TOP SLAB a purplish slate from Wales							
7	Stone mason or undertaker	NONE FOUND							
8	Which surfaces inscribed (facing N, S, E or W)								E
9	No. of people commemorated	2							
10	Condition of monument: 1=sound 2=displaced 3=leaning 4=collapsed 5=damaged								5
11	Technique of inscription: 1 = incised 2 = carved in relief 3 = cast in relief 4 = lead letters 5 = painted								1
12	Condition of inscription 1 = very good 2 = clear 3 = worn but decipherable 4 = partly legible 5 = illegible								3
13	Dimensions (metric)	MAX.	height	2	6	0			
			width	9	2	0			
			Thickness (or length in case of tombs)	1	8	4	0		
14	Date of memorial	1834 +	Register	Charles Marsh, Nutbourne bu.6 Nov., 1834, a.85					
		Hannah Phillips, Nutbourne, bu. 7 Jan. 1852 a.88							
	Drawing or Photograph	Inscription							

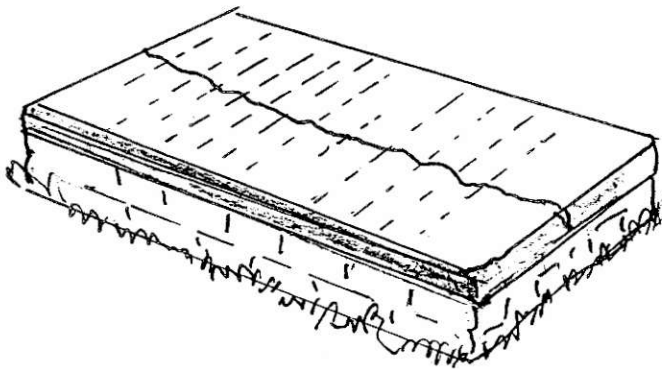

SACRED

TO THE MEMORY OF
 CHARLES MARSH
 WHO DIED AT NUTBOURNE
 IN THIS PARISH
 NOVEMBER 2 1834
 AGED 85 YEARS
 DEEPLY LAMENTED BY ALL WHO KNEW HIM

ALSO
 HANNAH PHILLIPS
 RELICT OF THE ABOVE
 WHO DIED JANUARY 4TH 1852
 AGED 88 YEARS

Grave Memorial Recording Form: St. John the Baptist, Westbourne, W. Sussex

1	National Grid Reference	755 073	Date	0	4	0	7	0	0
2	Name of recorder(s)	PETER MERYON							
3	Record No. of memorial (plus components i,ii,iii etc.)	N E B		1		9		7	
4	No. of components or inscribed faces (record on reverse if possible)								
5	Type of memorial: 1 = flat 2 = head 3 = tomb 4 = foot 5 = tablet 6 = other	2							
6	Material and geology	stone: limestone							
7	Stone mason or undertaker	none found							
8	Which surfaces inscribed (facing N, S, E or W)								E
9	No. of people commemorated								7
10	Condition of monument: 1=sound 2=displaced 3=leaning 4=collapsed 5=damaged								5
11	Technique of inscription: 1 = incised 2 = carved in relief 3 = cast in relief 4 = lead letters 5 = painted								1
12	Condition of inscription 1 = very good 2 = clear 3 = worn but decipherable 4 = partly legible 5 = illegible								4
13	Dimensions (metric)	height	9	6	0				
		width	6	6	0				
		Thickness (or length in case of tombs)		6	0				
14	Date of memorial 1801+	Register Joyce wife of John King bu.22 April 1792							
	John King bu.27 March 1801								

Drawing or Photograph

Inscription

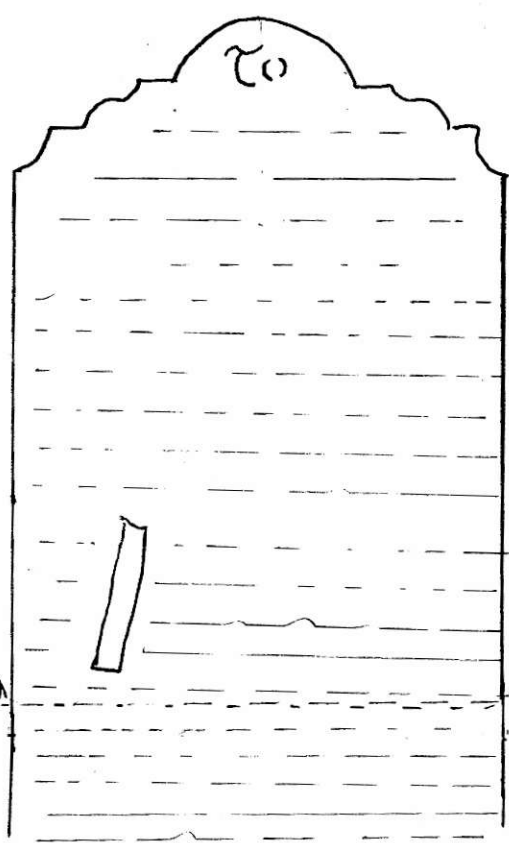

To
 the Memory of
 JOHN KING
 who died March 22nd 18[01]
 Aged 80 Years

With my loving wife and children dear
 I'm laid down and resting here
 Good people all that's passing by
 As you are now so once was I
 And as I am so shall you be
 Therefore prepare to follow me.

Also of JOICE Wife of JOHN
 KING who died April 19th 179[2]
 Aged 67 Years

A faithful Wife and Mother dear
 Has left this Life and lieth here
 May us that's left Religious live
 And Jesus will his blessing give
 If Death approaches none need sigh
 Eternal joys will then be nigh.
 Near this lies Five of their children

Repaired with metal rivets on both sides

year dates according to Sperling and register

Grave Memorial Recording Form: St. John the Baptist, Westbourne, W. Sussex

1	National Grid Reference	755 073	Date	2	5	0	7	0	0
2	Name of recorder(s)	DAPHNE MERYON							
3	Record No. of memorial (plus components i,ii,iii etc.)	N E B		1 9		8		i-ii	
4	No. of components or inscribed faces (record on reverse if possible)	2							
5	Type of memorial: 1 = flat 2 = head 3 = tomb 4 = foot 5 = tablet 6 = other	2							
6	Material and geology	STONE: Limestone							
7	Stone mason or undertaker	none found							
8	Which surfaces inscribed (facing N, S, E or W)								W
9	No. of people commemorated	1							
10	Condition of monument: 1=sound 2=displaced 3=leaning 4=collapsed 5=damaged	Some damage lower left. 3 metal rivets		5					
11	Technique of inscription: 1 = incised 2 = carved in relief 3 = cast in relief 4 = lead letters 5 = painted	traces of black paint		5 1					
12	Condition of inscription 1 = very good 2 = clear 3 = worn but decipherable 4 = partly legible 5 = illegible	2							
13	Dimensions (metric)	height	1	3	0	0			
		MAX. width		7	4	0			
		Thickness (or length in case of tombs)			7	0			
14	Date of memorial	1858+	Register Sophia Matilda Hawkins						
		the Matron of the Workhouse, Westbourne, bu- 10 th August 1858 a. 62.							
Drawing or Photograph					Inscription				

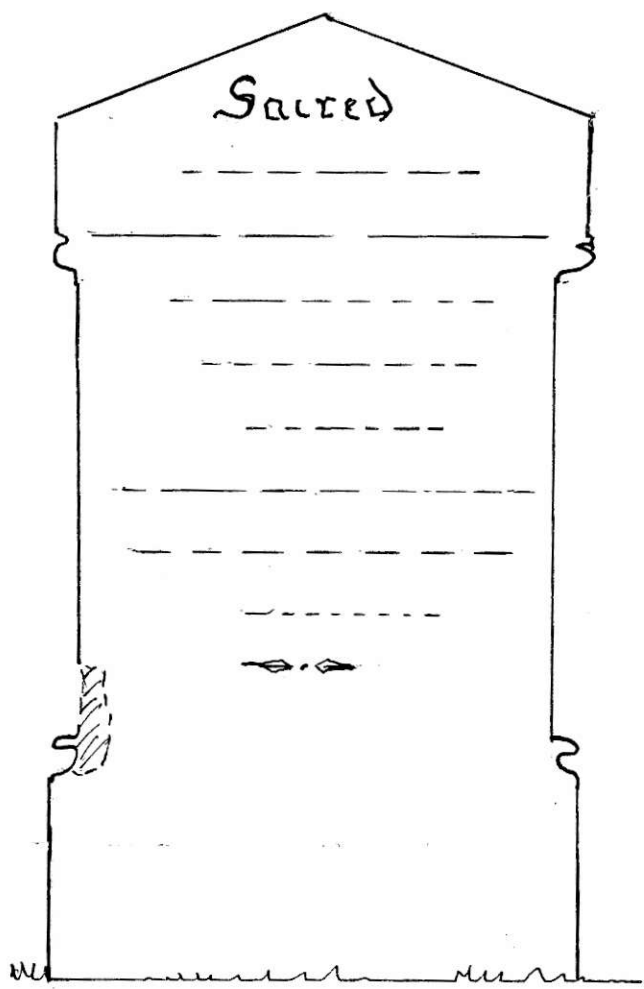

Sacred

TO THE MEMORY OF

SOPHIA MATILDA HAWKINS

who departed this life,

the 4th of August 1858,

Aged 62.

She was upwards of 22 years

the Matron of the Westbourne

Workhouse

◆ ◆

[i]

Over

NEB 198ii

FOOTSTONE

Limestone
faces E

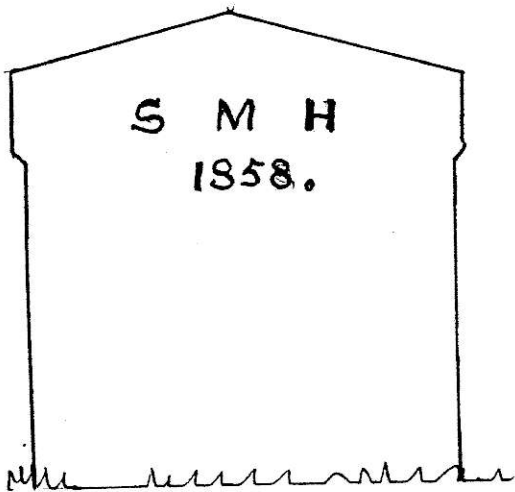

HEIGHT 64 cm

MAX. WIDTH 60

MIN. WIDTH 56

THICKNESS 6

Grave Memorial Recording Form: St. John the Baptist, Westbourne, W. Sussex

1	National Grid Reference	755 073	Date	1	1	0	7	0	0				
2	Name of recorder(s)	JOSEPHINE HALLETT											
3	Record No. of memorial (plus components i,ii,iii etc.)	N E B 1 9 9											
4	No. of components or inscribed faces (record on reverse if possible)	1											
5	Type of memorial: 1 = flat 2 = head 3 = tomb 4 = foot 5 = tablet 6 = other	2											
6	Material and geology	LIMESTONE											
7	Stone mason or undertaker	NONE FOUND											
8	Which surfaces inscribed (facing N, S, E or W)	W											
9	No. of people commemorated	1											
10	Condition of monument: 1=sound 2=displaced 3=leaning 4=collapsed 5=damaged	1											
11	Technique of inscription: 1 = incised 2 = carved in relief 3 = cast in relief 4 = lead letters 5 = painted	1											
12	Condition of inscription 1 = very good 2 = clear 3 = worn but decipherable 4 = partly legible 5 = illegible	3											
13	Dimensions (metric)	height	1	2	1	0	width	6	1	0	Thickness (or length in case of tombs)	7	0
14	Date of memorial	1845+	Register Anne Massey, Westbourne bu 23 June, 1845, aged 24										
Drawing or Photograph						Inscription							

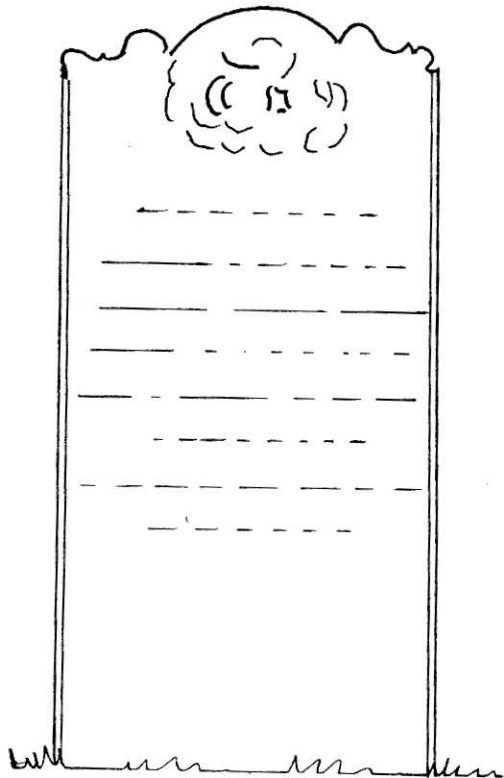

 the Memory of
 ANN, the Wife of
 GEORGE PETER WILLIAM
 MASSEY and Daughter of
 JOHN and ANN WOODMAN
 of Chichester
 who died the 20th of June 1845
 Aged 23 Years