

Grave Memorial Recording Form: St. John the Baptist, Westbourne, W. Sussex

1	National Grid Reference	755 073	Date	1	1	0	7	0	0
2	Name of recorder(s)	J. Storer							
3	Record No. of memorial (plus components i,ii,iii etc.)	N E B		2		0		0	
4	No. of components or inscribed faces (record on reverse if possible)	1							
5	Type of memorial: 1 = flat 2 = head 3 = tomb 4 = foot 5 = tablet 6 = other	3							
6	Material and geology	stone; limestone							
7	Stone mason or undertaker	none found							
8	Which surfaces inscribed (facing N, S, E or W)								S
9	No. of people commemorated	1							
10	Condition of monument: 1=sound 2=displaced 3=leaning 4=collapsed 5=damaged								1
11	Technique of inscription: 1 = incised 2 = carved in relief 3 = cast in relief 4 = lead letters 5 = painted								1
12	Condition of inscription 1 = very good 2 = clear 3 = worn but decipherable 4 = partly legible 5 = illegible								3
13	Dimensions (metric)	height	3	2	0				
		width	8	3	0				
		Thickness (or length in case of tombs)	2	1	9	5			
14	Date of memorial	1843 +	Register						
Frances Maria Smith, Racton, bu. 6 July 1843 aged 48									
Drawing or Photograph					Inscription				

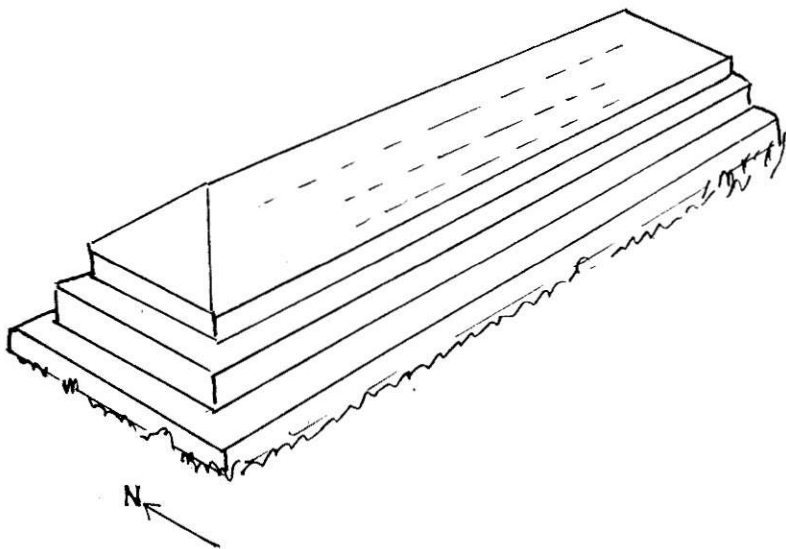

FRANCES MARIA SMITH
 STANSTED COTTAGE
 DIED 30 JUNE 1843

Grave Memorial Recording Form: St. John the Baptist, Westbourne, W. Sussex

1	National Grid Reference	755 073	Date	1	1	0	7	0	0
2	Name of recorder(s)	BERYL LINDER							
3	Record No. of memorial (plus components i,ii,iii etc.)	N	E	B		2	0	1	
4	No. of components or inscribed faces (record on reverse if possible)								
5	Type of memorial: 1 = flat 2 = head 3 = tomb 4 = foot 5 = tablet 6 = other	2							
6	Material and geology	LIMESTONE							
7	Stone mason or undertaker	NONE FOUND							
8	Which surfaces inscribed (facing N, S, E or W)	W							
9	No. of people commemorated	2							
10	Condition of monument: 1=sound 2=displaced 3=leaning 4=collapsed 5=damaged	1							
11	Technique of inscription: 1 = incised 2 = carved in relief 3 = cast in relief 4 = lead letters 5 = painted	1							
12	Condition of inscription 1 = very good 2 = clear 3 = worn but decipherable 4 = partly legible 5 = illegible	1							
13	Dimensions (metric)	Plinth + height		1	3	1	0		
		width			6	8	0		
		Thickness (or length in case of tombs)				6	0		
14	Date of memorial	1846 +	Register Julia Shean (Polling)						
		Caroline Shean of Lunley a. 28 bu. 27 March 1846			bu. 13 June 1885				
Drawing or Photograph					Inscription				

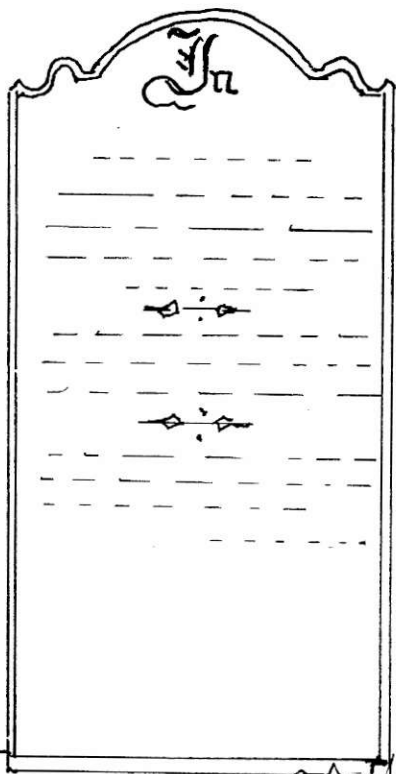

J.S.

MEMORY OF
 CAROLINE, DAUGHTER OF
 WILLIAM & MARIA SHEAN
 WHO DIED 22ND MARCH 1846
 AGED 28 YEARS
 —♦—♦—
 ALSO OF JULIA, A SISTER AND
 DAUGHTER OF THE ABOVE NAMED.
 BORN 5TH FEB^RY 1822. DIED 9TH JUNE 1885.
 —♦—♦—
 "IF WE BELIEVE THAT JESUS DIED AND ROSE
 AGAIN, EVEN SO THEM ALSO WHICH SLEEP
 JESUS WILL GOD BRING WITH HIM"
 I.THESS.IV.14

Grave Memorial Recording Form: St. John the Baptist, Westbourne, W. Sussex

1	National Grid Reference	755 073	Date	1	1	0	7	0	0
2	Name of recorder(s)	KEITH LINDBER							
3	Record No. of memorial (plus components i,ii,iii etc.)	N E B			2		0		2
4	No. of components or inscribed faces (record on reverse if possible)	2							
5	Type of memorial: 1 = flat 2 = head 3 = tomb 4 = foot 5 = tablet 6 = other	3							
6	Material and geology	STONE : LIMESTONE							
7	Stone mason or undertaker	NONE FOUND							
8	Which surfaces inscribed (facing N, S, E or W)				N	S			
9	No. of people commemorated	2							
10	Condition of monument: 1=sound 2=displaced 3=leaning 4=collapsed 5=damaged	5							
11	Technique of inscription: 1 = incised 2 = carved in relief 3 = cast in relief 4 = lead letters 5 = painted	1							
12	Condition of inscription 1 = very good 2 = clear 3 = worn but decipherable 4 = partly legible 5 = illegible	3							
13	Dimensions (metric)	height	3	3	0	width	7	1	5
		Thickness (or length in case of tombs)	1	9	5	5			
14	Date of memorial	1851 +	Register Maria bur. 22 May 1851 aged 70 William bur. 8 Jan. 1859 aged 71						
Drawing or Photograph					Inscription				

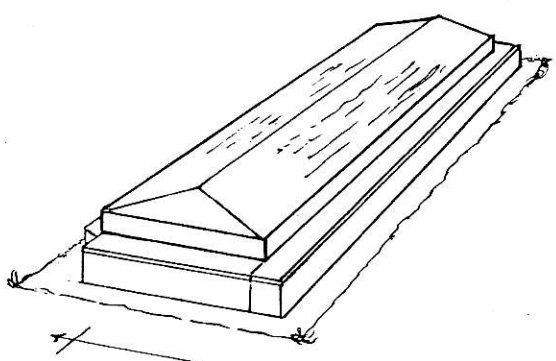

[NORTH FACE] IN MEMORY OF
 WILLIAM SHEAN,
 WHO DIED ON THE 3RD JANUARY 1859
 AGED 71 YEARS

[SOUTH FACE] IN MEMORY OF
 MARIA SHEAN,
 WHO DIED ON THE 15TH MAY 1851
 AGED 70 YEARS

Sp. William "Esq." of Lumley"

Grave Memorial Recording Form: St. John the Baptist, Westbourne, W. Sussex

1	National Grid Reference	755 073	Date	1	1	0	7	0	0
2	Name of recorder(s)	June Marshall							
3	Record No. of memorial (plus components i,ii,iii etc.)	N	E	B		2	0	3	
4	No. of components or inscribed faces (record on reverse if possible)								1
5	Type of memorial: 1 = flat 2 = head 3 = tomb 4 = foot 5 = tablet 6 = other								2
6	Material and geology	Limestone							
7	Stone mason or undertaker	NONE FOUND							
8	Which surfaces inscribed (facing N, S, E or W)								W
9	No. of people commemorated								1
10	Condition of monument: 1=sound 2=displaced 3=leaning 4=collapsed 5=damaged								1
11	Technique of inscription: 1 = incised 2 = carved in relief 3 = cast in relief 4 = lead letters 5 = painted								1 5
12	Condition of inscription 1 = very good 2 = clear 3 = worn but decipherable 4 = partly legible 5 = illegible								2
13	Dimensions (metric)	height	1	2	0	0			
		width		6	8	0			
		Thickness (or length in case of tombs)			6	0			
14	Date of memorial	1858+	Register George Shum Shean, Lumley, b u. 26 Aug. 1858 aged 33						

Drawing or Photograph

Inscription

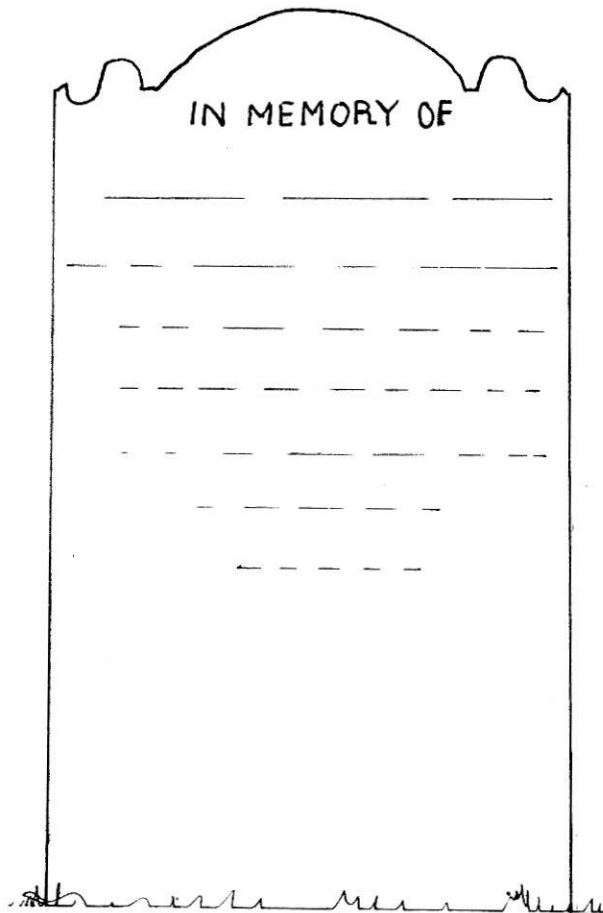

IN MEMORY OF
 GEORGE SHUM SHEAN
 Son of WILLIAM and MARIA SHEA
 who was drowned with three of
 his Friends in the upsetting
 of a boat in Emsworth Harbour
 August 21st 1858.
 Aged 33.

Two of the others who perished in this accident were Joseph Smith, also buried in Westbourne churchyard (no. NEB 138) and the Revd. Herbert Morse, curate of St. James's, Emsworth, who is buried in Warblington churchyard (no. SE 623 of the Warblington record). Morse was commemorated also by a tablet in St. James's Church, which gives a fuller account of the tragedy.

Grave Memorial Recording Form: St. John the Baptist, Westbourne, W. Sussex

1	National Grid Reference	755 073	Date	1	1	0	7	0	0
2	Name of recorder(s)	BERYL LINDER							
3	Record No. of memorial (plus components i,ii,iii etc.)	N	E	B		2	0	4	
4	No. of components or inscribed faces (record on reverse if possible)								
5	Type of memorial: 1 = flat 2 = head 3 = tomb 4 = foot 5 = tablet 6 = other	2							
6	Material and geology	LIMESTONE							
7	Stone mason or undertaker	NONE FOUND							
8	Which surfaces inscribed (facing N, S, E or W)	W							
9	No. of people commemorated	2							
10	Condition of monument: 1=sound 2=displaced 3=leaning 4=collapsed 5=damaged	1							
11	Technique of inscription: 1 = incised 2 = carved in relief 3 = cast in relief 4 = lead letters 5 = painted	1 5							
12	Condition of inscription 1 = very good 2 = clear 3 = worn but decipherable 4 = partly legible 5 = illegible	2							
13	Dimensions (metric)	height	1	1	9	0			
		width		9	2	0			
		Thickness (or length in case of tombs)			6	0			
14	Date of memorial 1801 or 1804 + Register	Rebecca, w. of John Brown bu. 12 Jan. 1801 John Brown bu. 14 Jan. 1804							
Drawing or Photograph					Inscription				

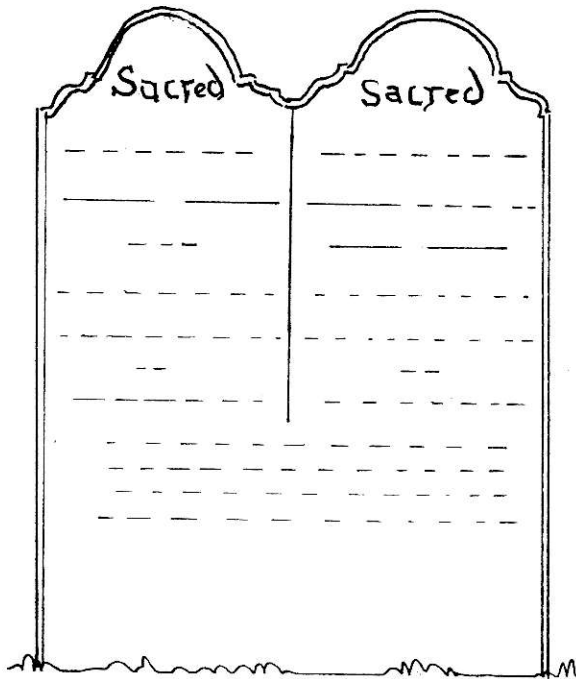

<p>Sacred</p> <p>to the Memory of</p> <p>JOHN BROWN</p> <p>Who</p> <p>departed this life</p> <p>the 11th of January 1804</p> <p>in</p> <p>the 63rd Year of his Age</p>	<p>Sacred</p> <p>to the Memory of</p> <p>REBECCA Wife of</p> <p>JOHN BROWN</p> <p>who departed this life</p> <p>the 7th of January 1801</p> <p>in</p> <p>the 64th Year of her Age</p>
--	---

Remember Death's the surest lot
 To all that in this World remain
 Altho' our bones consume and rot
 We trust in Christ to live again.

remains of black in line around edge.
 long & short s are thus.

Grave Memorial Recording Form: St. John the Baptist, Westbourne, W. Sussex

1	National Grid Reference	755 073	Date	1	1	0	7	0	0
2	Name of recorder(s)	KEITH LINDER							
3	Record No. of memorial (plus components i,ii,iii etc.)	N E B			2	0	5		
4	No. of components or inscribed faces (record on reverse if possible)	1							
5	Type of memorial: 1 = flat 2 = head 3 = tomb 4 = foot 5 = tablet 6 = other	3							
6	Material and geology	STONE: LIMESTONE							
7	Stone mason or undertaker	NONE FOUND							
8	Which surfaces inscribed (facing N, S, E or W)	S							
9	No. of people commemorated	1							
10	Condition of monument: 1=sound 2=displaced 3=leaning 4=collapsed 5=damaged	1							
11	Technique of inscription: 1 = incised 2 = carved in relief 3 = cast in relief 4 = lead letters 5 = painted	1							
12	Condition of inscription 1 = very good 2 = clear 3 = worn but decipherable 4 = partly legible 5 = illegible	2							
13	Dimensions (metric)	height	3	3	0				
		width	7	1	5				
		Thickness (or length in case of tombs)	2	0	0	0			
14	Date of memorial	1849+	Register James Brown bu. Nov. 3 rd 1849 aged 73						

Drawing or Photograph

Inscription

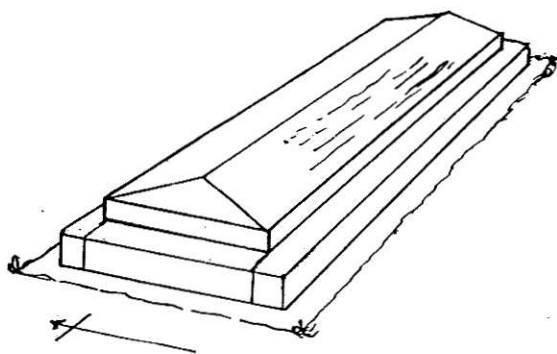

[SOUTH SLOPE:]

SACRED to the Memory of
 JAMES BROWN
 who died the 27th of October 1849
 Aged 73 Years

Grave Memorial Recording Form: St. John the Baptist, Westbourne, W. Sussex

1	National Grid Reference	755 073	Date	11	1	0	7	0	0					
2	Name of recorder(s)	KEITH LINDER												
3	Record No. of memorial (plus components i,ii,iii etc.)	N E B			2			0 6						
4	No. of components or inscribed faces (record on reverse if possible)													
5	Type of memorial: 1 = flat 2 = head 3 = tomb 4 = foot 5 = tablet 6 = other	3												
6	Material and geology	STONE: LIMESTONE												
7	Stone mason or undertaker	NONE FOUND												
8	Which surfaces inscribed (facing N, S, E or W)				N		E		S					
9	No. of people commemorated	2												
10	Condition of monument: 1=sound 2=displaced 3=leaning 4=collapsed 5=damaged	5												
11	Technique of inscription: 1 = incised 2 = carved in relief 3 = cast in relief 4 = lead letters 5 = painted	1												
12	Condition of inscription 1 = very good 2 = clear 3 = worn but decipherable 4 = partly legible 5 = illegible	3												
13	Dimensions (metric)	height	3	7	0	width	7	5	0	Thickness (or length in case of tombs)	1	9	7	0
14	Date of memorial	1857 +	Register Mary d. of John & Rebecca Brown bu. 15 Dec. 1786 Phyllis Brown, Westbourne, bu. 13 June 1857, a. 74											
Drawing or Photograph											Inscription			

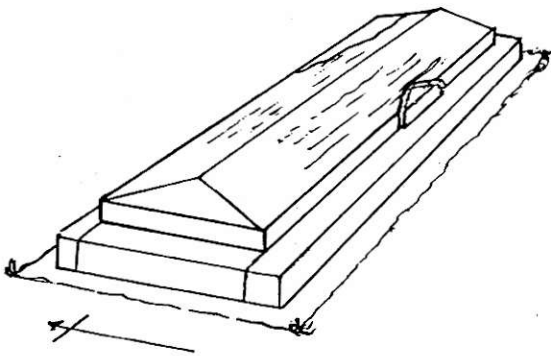

NORTH FACE:

SACRED TO THE MEMORY OF
PHILLISS BROWN

WHO DIED THE 8TH OF JUNE 1857
AGED 74 YEARS

SOUTH FACE:

SACRED TO THE MEMORY OF

MARY BROWN,

WHO DIED THE 13TH OF DECEMBER 1786
AGED 6 YEARS

Grave Memorial Recording Form: St. John the Baptist, Westbourne, W. Sussex

1	National Grid Reference	755 073	Date	1	8	0	7	0	0
2	Name of recorder(s)	KEITH LINDER							
3	Record No. of memorial (plus components i,ii,iii etc.)	N E B			2			0 7	
4	No. of components or inscribed faces (record on reverse if possible)	1							
5	Type of memorial: 1 = flat 2 = head 3 = tomb 4 = foot 5 = tablet 6 = other	2							
6	Material and geology	STONE: LIMESTONE							
7	Stone mason or undertaker	NONE FOUND							
8	Which surfaces inscribed (facing N, S, E or W)								W
9	No. of people commemorated	1							
10	Condition of monument: 1=sound 2=displaced 3=leaning 4=collapsed 5=damaged								3
11	Technique of inscription: 1 = incised 2 = carved in relief 3 = cast in relief 4 = lead letters 5 = painted								1
12	Condition of inscription 1 = very good 2 = clear 3 = worn but decipherable 4 = partly legible 5 = illegible								1
13	Dimensions (metric)	height	5	6	0	width	6	4	0
		Thickness (or length in case of tombs)		8	5				
14	Date of memorial	1727 +	Register Henry Oliver bu. 23 Dec 1727						

Drawing or Photograph

Inscription

IN MEMORY
 of HENRY OLLIVER Who
 Died December 21st
 1727 Aged 52 Years
 Man is y seed God is y sowe
 Man is y grass death is y mowe
 My time my life My days are
 past to My long home

IN MEMORY
 of HENRY OLLIVER Who
 Died December 21st
 1727 Aged 52 Years
 Man is y seed God is y sowe
 Man is y grass death is y mowe
 My time my life My days are
 past to My long home I am got
 at last

Grave Memorial Recording Form: St. John the Baptist, Westbourne, W. Sussex

1	National Grid Reference	755 073	Date	1	2	0	9	0	0
2	Name of recorder(s)	DAPHNE COOPER							
3	Record No. of memorial (plus components i,ii,iii etc.)	N E B		2	0	8			
4	No. of components or inscribed faces (record on reverse if possible)								
5	Type of memorial: 1 = flat 2 = head 3 = tomb 4 = foot 5 = tablet 6 = other								
6	Material and geology	LIMESTONE							
7	Stone mason or undertaker	NONE FOUND							
8	Which surfaces inscribed (facing N, S, E or W)	W							
9	No. of people commemorated	3							
10	Condition of monument: 1=sound 2=displaced 3=leaning 4=collapsed 5=damaged	1							
11	Technique of inscription: 1 = incised 2 = carved in relief 3 = cast in relief 4 = lead letters 5 = painted	1							
12	Condition of inscription 1 = very good 2 = clear 3 = worn but decipherable 4 = partly legible 5 = illegible	2							
13	Dimensions (metric)	height	1	3	4	0			
		width		6	3	0			
		Thickness (or length in case of tombs)			7	0			
14	Date of memorial	1842+ (or 1839+) Register Anne White, Woodmancote, bu. 22 Sept Elizabeth Esther White, Woodmancote, bu. 21 Nov. 1839 a. 10 // 1842, a. 24							
Drawing or Photograph					Inscription				

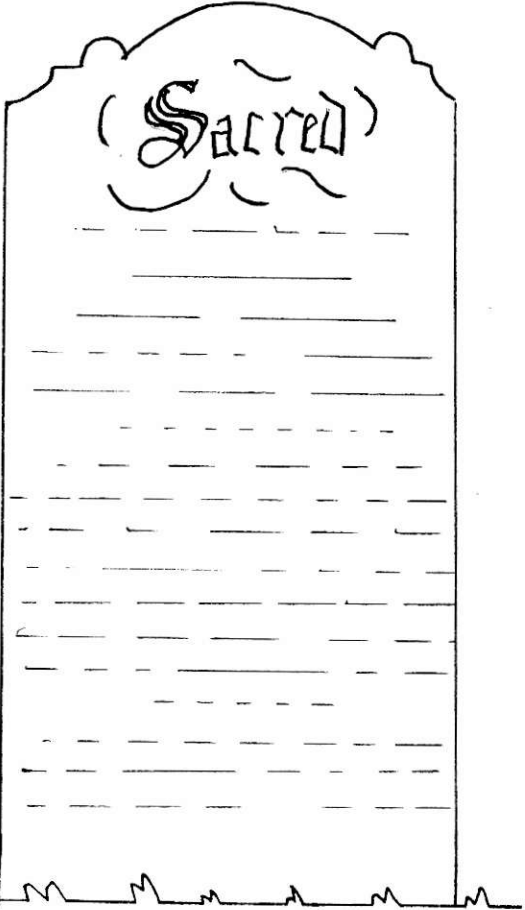

(Sacred)

to the Memory of
**ELIZABETH
 ESTHER WHITE**
 Daughter of THOMAS and
ANN CLARK WHITE
 Of WOODMANCOTE
 who departed this Life
 the 16th of November 1839
 Aged 10 Years and 5 Months
 Also of ANN eldest Daughter of
 the above named THOMAS and
ANN CLARK WHITE
 who Died the 18th of September 1842
 Aged 24 Years
 The Lord gave and the Lord hath
 Taken away Blessed be the name
 of the Lord. Job 1st Chap 21st v

Footstone is no. NW 92

Grave Memorial Recording Form: St. John the Baptist, Westbourne, W. Sussex

1	National Grid Reference	755 073	Date	1	1	0	7	0	0
2	Name of recorder(s)	Veronica Jay							
3	Record No. of memorial (plus components i,ii,iii etc.)	N	E	B		2	0	9	
4	No. of components or inscribed faces (record on reverse if possible)								
5	Type of memorial: 1 = flat 2 = head 3 = tomb 4 = foot 5 = tablet 6 = other								
6	Material and geology	LIMESTONE							
7	Stone mason or undertaker	NONE FOUND							
8	Which surfaces inscribed (facing N, S, E or W)								
9	No. of people commemorated								
10	Condition of monument: 1=sound 2=displaced 3=leaning 4=collapsed 5=damaged								
11	Technique of inscription: 1 = incised 2 = carved in relief 3 = cast in relief 4 = lead letters 5 = painted								
12	Condition of inscription 1 = very good 2 = clear 3 = worn but decipherable 4 = partly legible 5 = illegible								
13	Dimensions (metric)	height	1	3	1	0			
		width		5	9	0			
		Thickness (or length in case of tombs)			6	5			
14	Date of memorial	1828+	Register	John Rogers, Westbourne, bu. 4 Sept.					
		Sarah Rogers, Westbourne, bu. 12 November, 1845 a. 86 // 1828, a. 72							
Drawing or Photograph					Inscription				

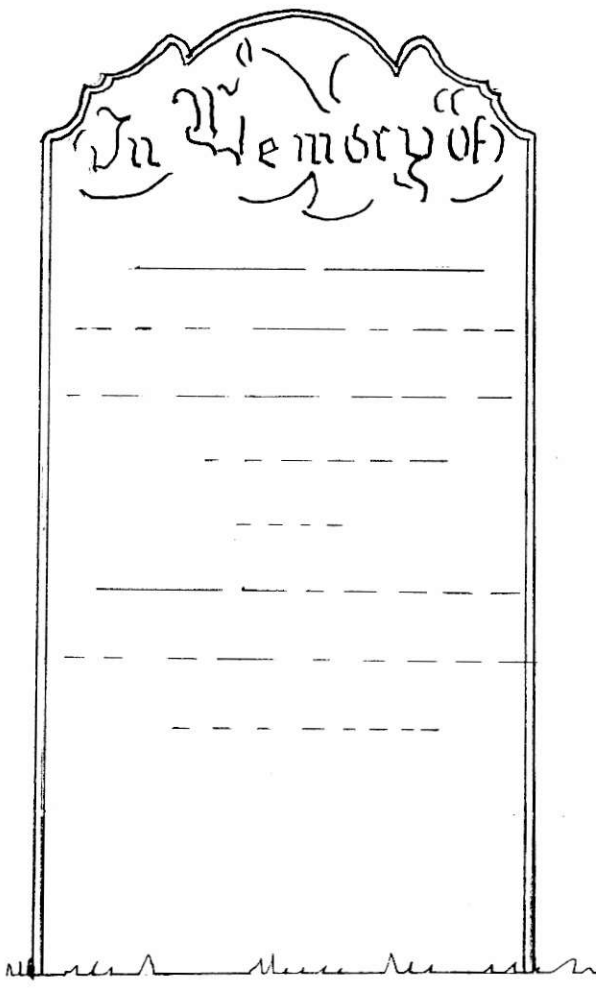

In Memory of

JOHN ROGERS
 Late of Atherfield, Isle of Wight
 who died August the 31 1828
 Aged 72 Years
 Also
 SARAH wife of the above
 who died November the 8th 1845
 Aged 86 Years

Grave Memorial Recording Form: St. John the Baptist, Westbourne, W. Sussex

1	National Grid Reference	755 073	Date	1	8	0	7	0	0
2	Name of recorder(s)	DAPHNE COOPER							
3	Record No. of memorial (plus components i,ii,iii etc.)	N E B		2	1	0			
4	No. of components or inscribed faces (record on reverse if possible)	1							
5	Type of memorial: 1 = flat 2 = head 3 = tomb 4 = foot 5 = tablet 6 = other	2							
6	Material and geology	LIMESTONE							
7	Stone mason or undertaker	NONE FOUND							
8	Which surfaces inscribed (facing N, S, E or W)								W
9	No. of people commemorated	2							
10	Condition of monument: 1=sound 2=displaced 3=leaning 4=collapsed 5=damaged								1
11	Technique of inscription: 1 = incised 2 = carved in relief 3 = cast in relief 4 = lead letters 5 = painted								1
12	Condition of inscription 1 = very good 2 = clear 3 = worn but decipherable 4 = partly legible 5 = illegible								4
13	Dimensions (metric)	height	1	1	5	5			
		width		6	4	0			
		Thickness (or length in case of tombs)			6	0			
14	Date of memorial	1813+	Register	James s. of William & Ann Barnes bu. 25 Nov. 1793 // Henrys. of William & Ann Barnes bu. 10 Aug. 1813 a. 24					
Drawing or Photograph					Inscription				

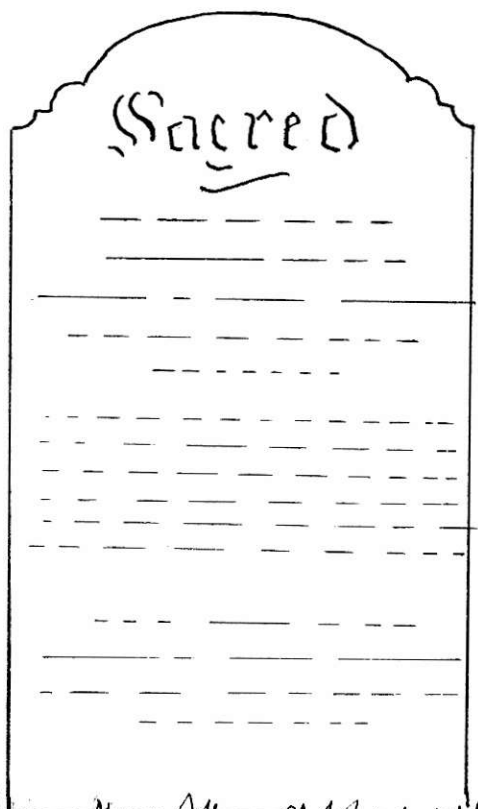

Sacred
to the Memory of
HARRY Son of
WILLIAM and ANN BARNES
who died August 15th 1813
Aged 24 Years
D. --- Friend of --- [play]
D. --- [away]
After a long decay of Life
It pleased GOD to end the strife
As this my fate so yours may be
Therefore prepare to follow me
Also JAMES Son of
WILLIAM and ANN BARNES
who died Nov^r 12th 1793
Aged 15 Months

Confusion between Bains, Barnes & Barnes
in register & inscription.

Grave Memorial Recording Form: St. John the Baptist, Westbourne, W. Sussex

1	National Grid Reference	755 073	Date	3	0	1	0	0	1
2	Name of recorder(s)	BERYL LINDER							
3	Record No. of memorial (plus components I, II, III etc.)	N E B 2 1 1							
4	No. of components or inscribed faces (record on reverse if possible)	1							
5	Type of memorial: 1 = flat 2 = head 3 = tomb 4 = foot 5 = tablet 6 = other	2							
6	Material and geology	LIMESTONE							
7	Stone mason or undertaker	NONE FOUND							
8	Which surfaces inscribed (facing N, S, E or W)								W
9	No. of people commemorated	1							
10	Condition of monument: 1=sound 2=displaced 3=leaning 4=collapsed 5=damaged								3
11	Technique of inscription: 1 = incised 2 = carved in relief 3 = cast in relief 4 = lead letters 5 = painted								1
12	Condition of inscription 1 = very good 2 = clear 3 = worn but decipherable 4 = partly legible 5 = illegible								1
13	Dimensions (metric)	height	1	2	7	0			
		width		7	4	0			
		Thickness (or length in case of tombs)			7	5			
14	Date of memorial	1834 +	Register John Ayling bu. 4 Apr. 1834, a. 32						

Drawing or Photograph

Inscription





SACRED

*to the Memory of
JOHN AYLING
who departed this Life
the 26th of March 1834
Aged 32 Years*

Grave Memorial Recording Form: St. John the Baptist, Westbourne, W. Sussex

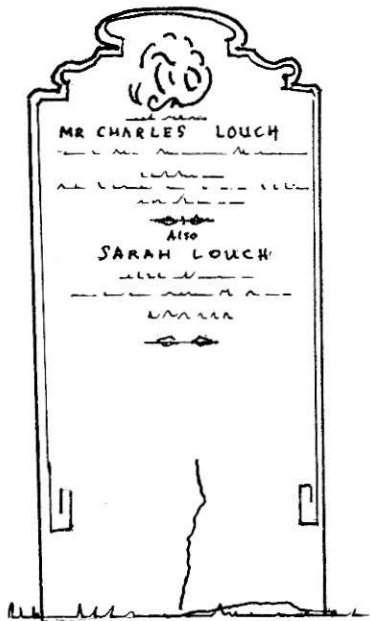
1	National Grid Reference	755 073	Date	2	5	0	7	0	0
2	Name of recorder(s)	JOHN LAMPLUGH							
3	Record No. of memorial (plus components i,ii,iii etc.)	N	E	B		2	1	2	
4	No. of components or inscribed faces (record on reverse if possible)								1
5	Type of memorial: 1 = flat 2 = head 3 = tomb 4 = foot 5 = tablet 6 = other								2
6	Material and geology	limestone							
7	Stone mason or undertaker	none found							
8	Which surfaces inscribed (facing N, S, E or W)								W
9	No. of people commemorated								2
10	Condition of monument: 1=sound 2=displaced 3=leaning 4=collapsed 5=damaged								3
11	Technique of inscription: 1 = incised 2 = carved in relief 3 = cast in relief 4 = lead letters 5 = painted								1
12	Condition of inscription 1 = very good 2 = clear 3 = worn but decipherable 4 = partly legible 5 = illegible								3
13	Dimensions (metric)	height	1	6	0	0			
		width		7	5	5			
		Thickness (or length in case of tombs)			7	0			
14	Date of memorial	1844+	Register Charles Louch, Portsmouth b. 5 Nov. 1844, aged 64						
	Sarah Louch, Clifton, Bristol, bur. 5 Jan. 1858 aged 78								
	Drawing or Photograph	Inscription							





 THE MEMORY OF
MR CHARLES LOUCH
 for many years Deputy Storekeeper
 at Gravesend
 who departed this life Nov^r 1844
 Aged 64 Years
 ———
 Also
SARAH LOUCH
 wife of the above
 who died December 31st 1857.
 Aged 79 Years
 ———

traces of paint in border line

Grave Memorial Recording Form: St. John the Baptist, Westbourne, W. Sussex

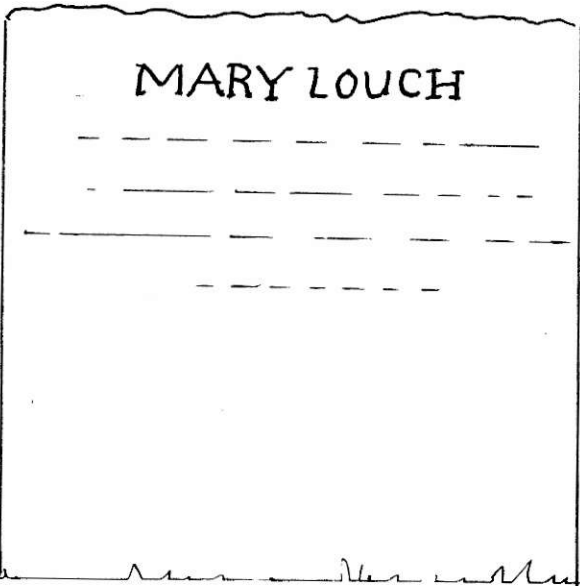
1	National Grid Reference	755 073	Date	2	5	0	7	0	0
2	Name of recorder(s)	BERYL LINDER							
3	Record No. of memorial (plus components i,ii,iii etc.)	N	E	B			2	1	3
4	No. of components or inscribed faces (record on reverse if possible)								
5	Type of memorial: 1 = flat 2 = head 3 = tomb 4 = foot 5 = tablet 6 = other	2							
6	Material and geology	LIMESTONE : PORTLAND TYPE							
7	Stone mason or undertaker	NONE FOUND							
8	Which surfaces inscribed (facing N, S, E or W)								W
9	No. of people commemorated	Originally two							
10	Condition of monument: 1=sound 2=displaced 3=leaning broken; top half 4=collapsed 5=damaged	missing 3 5							
11	Technique of inscription: 1 = incised 2 = carved in relief 3 = cast in relief 4 = lead letters 5 = painted	1 5							
12	Condition of inscription 1 = very good 2 = clear 3 = worn but decipherable 4 = partly legible 5 = illegible	4							
13	Dimensions (metric)	height	7	5	0	width	7	6	0
		Thickness (or length in case of tombs)		7	0				
14	Date of memorial	Probably 1826	Register	Mary Louch, Hermitage, bu. 31 Jan. 1832 aged 80					
		Richard Louch bu. 30 Oct. 1826 aged 72							
	Drawing or Photograph	Inscription							



MARY LOUCH
 the Wife of the above
 who departed this Life
 the 26th day of January 1832
 Aged 80 Years

missing section apparently commemorated Richard Louch (according to Sperling) d. Oct. 24, 1826, a-75.

Footstone OV 654

Grave Memorial Recording Form: St. John the Baptist, Westbourne, W. Sussex

1	National Grid Reference	755 073	Date	3	0	0	5	0	0
2	Name of recorder(s)	KEITH LINDER							
3	Record No. of memorial (plus components i,ii,iii etc.)	N E B			2	1	4		
4	No. of components or inscribed faces (record on reverse if possible)	1							
5	Type of memorial: 1 = flat 2 = head 3 = tomb 4 = foot 5 = tablet 6 = other	2							
6	Material and geology	STONE : LIMESTONE							
7	Stone mason or undertaker	NONE FOUND							
8	Which surfaces inscribed (facing N, S, E or W)								W
9	No. of people commemorated	1							
10	Condition of monument: 1=sound 2=displaced 3=leaning 4=collapsed 5=damaged								1
11	Technique of inscription: 1 = incised 2 = carved in relief 3 = cast in relief 4 = lead letters 5 = painted								1
12	Condition of inscription 1 = very good 2 = clear 3 = worn but decipherable 4 = partly legible 5 = illegible								1
13	Dimensions (metric)	height	1	1	6	0			
		width		6	3	0			
		Thickness (or length in case of tombs)			7	0			
14	Date of memorial	1786+	Register Elizabeth w. of Thomas Clear Sen ^r . bu. 11 Feb. 1786						
Drawing or Photograph					Inscription				

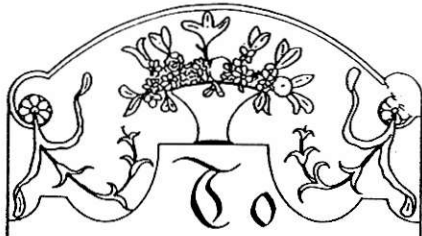

the Memory of
ELIZABETH CLEAR
 wife of **THOMAS CLEAR**
 who departed this life
 February the 11th 1786
 Aged 19 Years

*From Cares remov'd sleeps peaceful here
 A loving Wife a Mother dear
 Though parting wraps our Souls in Grief
 From Heaven flows this kind Relief
 That we shall meet on that blest Shore
 Where Tears and Sorrows are no more*

To

the Memory of
ELIZABETH CLEAR
 wife of **THOMAS CLEAR**
 who departed this life
 February the 11th 1786
 Aged 49 Years

*From Cares remov'd sleeps peaceful here
 A loving Wife a Mother dear
 Though parting wraps our Souls in Grief
 From Heaven flows this kind Relief:
 That we shall meet on that blest Shore
 Where Tears and Sorrows are no more.*

Grave Memorial Recording Form: St. John the Baptist, Westbourne, W. Sussex

1	National Grid Reference	755 073	Date	2	8	7	0	0
2	Name of recorder(s)	SHIRLEY HARVEY-WHITING.						
3	Record No. of memorial (plus components i,ii,iii etc.)	N E B 2 1 5						
4	No. of components or inscribed faces (record on reverse if possible)							
5	Type of memorial: 1 = flat 2 = head 3 = tomb 4 = foot 5 = tablet 6 = other	2						
6	Material and geology	STONE : LIMESTONE						
7	Stone mason or undertaker	NONE FOUND						
8	Which surfaces inscribed (facing N, S, E or W)							W
9	No. of people commemorated							1
10	Condition of monument: 1=sound 2=displaced 3=leaning 4=collapsed 5=damaged							3
11	Technique of inscription: 1 = incised 2 = carved in relief 3 = cast in relief 4 = lead letters 5 = painted							1
12	Condition of inscription 1 = very good 2 = clear 3 = worn but decipherable 4 = partly legible 5 = illegible							2
13	Dimensions (metric)	height	1	4	3	0		
		width		8	7	0		
		Thickness (or length in case of tombs)			7	0		
14	Date of memorial	1808 +	Register not found; April 1808 - April 1809 missing					
Drawing or Photograph				Inscription				

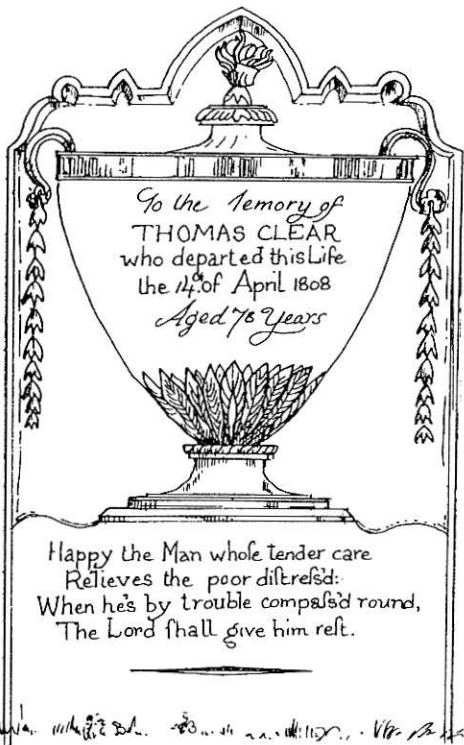

To the memory of
 THOMAS CLEAR
 who departed this life
 the 14th of April 1808
 Aged 78 years

Happy the Man whose tender care
 Relieves the poor distressed:
 When he's by trouble compass'd round,
 The Lord shall give him rest.

Grave Memorial Recording Form: St. John the Baptist, Westbourne, W. Sussex

1	National Grid Reference	755 073	Date	27	6	0	0	
2	Name of recorder(s)	SHIRLEY HARVEY-WHITING.						
3	Record No. of memorial (plus components i,ii,iii etc.)	N	E	B	2	1	6	
4	No. of components or inscribed faces (record on reverse if possible)							1
5	Type of memorial: 1 = flat 2 = head 3 = tomb 4 = foot 5 = tablet 6 = other							2
6	Material and geology	LIMESTONE						
7	Stone mason or undertaker	NONE FOUND						
8	Which surfaces inscribed (facing N, S, E or W)							W
9	No. of people commemorated							2
10	Condition of monument: 1=sound 2=displaced 3=leaning 4=collapsed 5=damaged							3
11	Technique of inscription: 1 = incised 2 = carved in relief 3 = cast in relief 4 = lead letters 5 = painted							1
12	Condition of inscription 1 = very good 2 = clear 3 = worn but decipherable 4 = partly legible 5 = illegible							1
13	Dimensions (metric)	height	1	1	2	0		
		width		6	8	0		
		Thickness (or length in case of tombs)			7	0		
14	Date of memorial	28.10.1781 / 17.4.1802	Register	Stephen Palmer bu 23 Oct. 1781				
	Ann Palmer, widow, bu. 21 April 1802							
Drawing or Photograph				Inscription				



the Memory of
 STEPHEN PALMER
 who departed this Life
 the 28th of October 1781
 Aged 38 Years
also
 ANN Wife of
 STEPHEN PALMER
 who departed this life
 the 17th of April 1802
 Aged 84 Years

the Memory of
 STEPHEN PALMER
 who departed this Life
 the 28th of October 1781
 Aged 38 Years
also
 ANN Wife of
 STEPHEN PALMER
 who departed this life
 the 17th of April 1802
 Aged 84 Years

There is a discrepancy between dates of Stephen's death & burial

Grave Memorial Recording Form: St. John the Baptist, Westbourne, W. Sussex

1	National Grid Reference	155 073	Date	2	0	0	6	0	0
2	Name of recorder(s)	John Lamplugh							
3	Record No. of memorial (plus components i,ii,iii etc.)	N	E	B			2	1	7
4	No. of components or inscribed faces (record on reverse if possible)								
5	Type of memorial: 1 = flat 2 = head 3 = tomb 4 = foot 5 = tablet 6 = other								
6	Material and geology	LIMESTONE							
7	Stone mason or undertaker	NONE FOUND							
8	Which surfaces inscribed (facing N, S, E or W)								
9	No. of people commemorated								
10	Condition of monument: 1=sound 2=displaced 3=leaning 4=collapsed 5=damaged	(5) below ground							
11	Technique of inscription: 1 = incised 2 = carved in relief 3 = cast in relief 4 = lead letters 5 = painted								
12	Condition of inscription 1 = very good 2 = clear 3 = worn but decipherable 4 = partly legible 5 = illegible								
13	Dimensions (metric)	height	1	0	4	0			
		width		6	1	0			
		Thickness (or length in case of tombs)			7	0			
14	Date of memorial	1759 +	Register Ann w. of Henry Hounsom bu. 2 Jun 1759						
		Catherine D. of Henry Hounsom bu. 30 Jun. 1760							
Drawing or Photograph					Inscription				

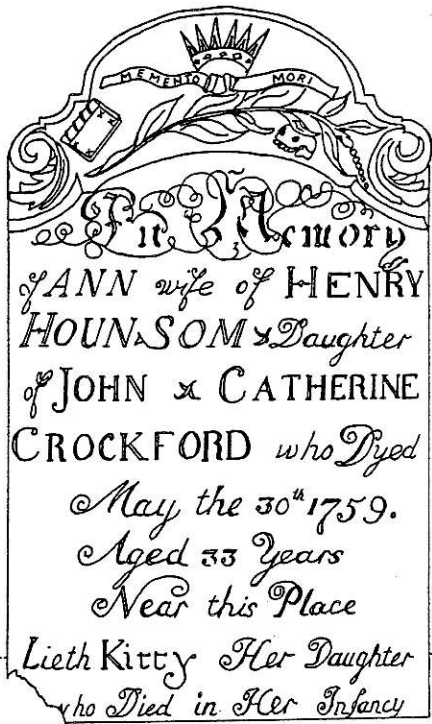

In Memory
of ANN wife of HENRY
HOUNSOM & Daughter
of JOHN & CATHERINE
CROCKFORD who Dyed
May the 30th 1759.
Aged 33 Years
Near this Place
Lieth Kitty Her Daughter
who Died in Her Infancy



IN MEMORY

of ANN wife of HENRY
HOUNSOM & Daughter
of JOHN & CATHERINE
CROCKFORD who Dyed

May the 30th 1759.

Aged 33 Years

Near this Place

Lieth Kitty Her Daughter
who Died in Her Infancy

Ground level

Grave Memorial Recording Form: St. John the Baptist, Westbourne, W. Sussex

1	National Grid Reference	755 073	Date	1	1	7	0	0
2	Name of recorder(s)	SHIRLEY HARVEY-WHITING.						
3	Record No. of memorial (plus components i,ii,iii etc.)	N	E	B	2	1	8	
4	No. of components or inscribed faces (record on reverse if possible)							
5	Type of memorial: 1 = flat 2 = head 3 = tomb 4 = foot 5 = tablet 6 = other	2						
6	Material and geology	STONE LIMESTONE						
7	Stone mason or undertaker	NONE FOUND						
8	Which surfaces inscribed (facing N, S, E or W)	W						
9	No. of people commemorated	1						
10	Condition of monument: 1=sound 2=displaced 3=leaning 4=collapsed 5=damaged	3						
11	Technique of inscription: 1 = incised 2 = carved in relief 3 = cast in relief 4 = lead letters 5 = painted	2						
12	Condition of inscription 1 = very good 2 = clear 3 = worn but decipherable 4 = partly legible 5 = illegible	1						
13	Dimensions (metric)	height	8	9	0			
		width	5	4	5			
		Thickness (or length in case of tombs)	7	0				
14	Date of memorial	1763 +	Register Catherine Crockford widow bu. 9 Dec. 1763					
Drawing or Photograph				Inscription				



Inge
 Inge
 Memory of
 CATHERINE Wife of
 John CROCKFORD
 who Departed this Life
 December the 4th 1763
 In the 65 year
 of Her Age.

Inge
 Inge
 Memory of
 CATHERINE Wife of
 John CROCKFORD
 who Departed this Life
 December the 4th 1763
 In the 65 year
 of Her Age.

Grave Memorial Recording Form: St. John the Baptist, Westbourne, W. Sussex

1	National Grid Reference	755 073	Date	0	4	0	7	0	0
2	Name of recorder(s)	KEITH LINDER							
3	Record No. of memorial (plus components i,ii,iii etc.)	N E B		2	1	9			
4	No. of components or inscribed faces (record on reverse if possible)	1							
5	Type of memorial: 1 = flat 2 = head 3 = tomb 4 = foot 5 = tablet 6 = other	2							
6	Material and geology	STONE: LIMESTONE							
7	Stone mason or undertaker	NONE FOUND							
8	Which surfaces inscribed (facing N, S, E or W)								W
9	No. of people commemorated	1							
10	Condition of monument: 1=sound 2=displaced 3=leaning 4=collapsed 5=damaged								1
11	Technique of inscription: 1 = incised 2 = carved in relief 3 = cast in relief 4 = lead letters 5 = painted								1
12	Condition of inscription 1 = very good 2 = clear 3 = worn but decipherable 4 = partly legible 5 = illegible								3
13	Dimensions (metric)	height	1	2	4	5			
		width		7	5	0			
		Thickness (or length in case of tombs)			7	5			
14	Date of memorial 1813 +	Register Sarah Diggins (Widow) of Emsworth, bu- 9 July 1813 aged 62							
Drawing or Photograph					Inscription				

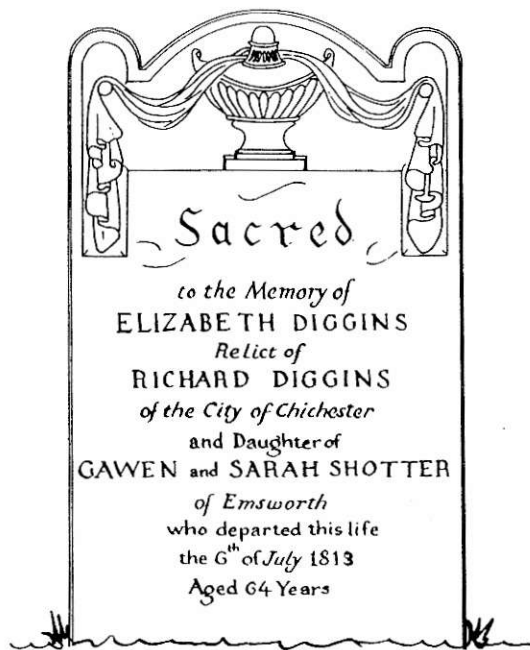

Sacred
to the Memory of
ELIZABETH DIGGINS
Relict of
RICHARD DIGGINS
of the City of Chichester
and Daughter of
GAWEN and SARAH SHOTTER
of Emsworth
who departed this life
the 6th of July 1813
Aged 64 Years

Grave Memorial Recording Form: St. John the Baptist, Westbourne, W. Sussex

1	National Grid Reference	755 073	Date	1	8	0	7	0	0
2	Name of recorder(s)	KEITH LINDER							
3	Record No. of memorial (plus components i,ii,iii etc.)	N E B 2 2 0							
4	No. of components or inscribed faces (record on reverse if possible)	1							
5	Type of memorial: 1 = flat 2 = head 3 = tomb 4 = foot 5 = tablet 6 = other	2							
6	Material and geology	STONE: LIMESTONE							
7	Stone mason or undertaker	NONE FOUND							
8	Which surfaces inscribed (facing N, S, E or W)								W
9	No. of people commemorated	2							
10	Condition of monument: 1=sound 2=displaced 3=leaning 4=collapsed 5=damaged	FALLEN FACE DOWN 5 4							
11	Technique of inscription: 1 = incised 2 = carved in relief 3 = cast in relief 4 = lead letters 5 = painted	1							
12	Condition of inscription 1 = very good 2 = clear 3 = worn but decipherable 4 = partly legible 5 = illegible	1							
13	Dimensions (metric)	height	1	5	7	0			
		width		7	1	5			
		Thickness (or length in case of tombs)			7	0			
14	Date of memorial	1796 +	Register	Sarah Shotter bu. 9 Jan 1796 Elizabeth not found					
Drawing or Photograph					Inscription				

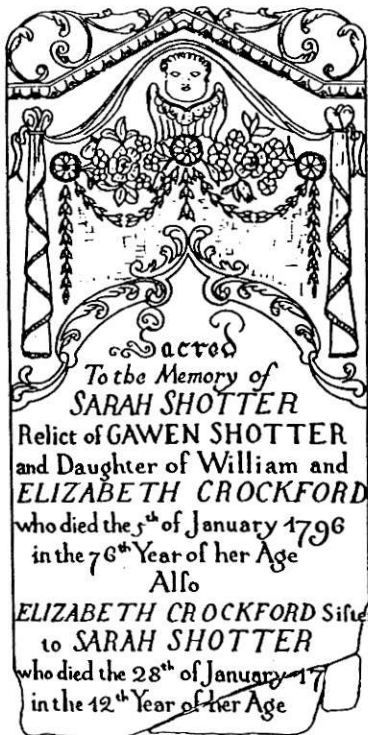

Sacred
 To the Memory of
SARAH SHOTTER
 Relict of GAWEN SHOTTER
 and Daughter of William and
ELIZABETH CROCKFORD
 who died the 5th of January 1796
 in the 76th Year of her Age
 Also
ELIZABETH CROCKFORD Sister
 to **SARAH SHOTTER**
 who died the 28th of January 1771
 in the 12th Year of her Age

THE STONE SNAPPED AT THE BASE AND WAS REPAIRED WITH IRON STRAPS. IT BROKE AGAIN AND FELL WITH THE INSCRIPTION DOWNWARDS. THE FACE OF THE STONE HAS NOT WEATHERED AND HAS RETAINED ITS ORIGINAL WHITE COLOUR.

* 1733 or 1753; Sperling gives 1733 and age 42. 1733 and age 12 seem most likely.

Grave Memorial Recording Form: St. John the Baptist, Westbourne, W. Sussex

1	National Grid Reference	755 073	Date	0	1	0	8	0	0
2	Name of recorder(s)	KEITH LINDER							
3	Record No. of memorial (plus components i,ii,iii etc.)	N E B		2 2		1			
4	No. of components or inscribed faces (record on reverse if possible)								
5	Type of memorial: 1 = flat 2 = head 3 = tomb 4 = foot 5 = tablet 6 = other								
6	Material and geology	STONE : LIMESTONE							
7	Stone mason or undertaker	NONE FOUND							
8	Which surfaces inscribed (facing N, S, E or W)	W							
9	No. of people commemorated	2							
10	Condition of monument: 1=sound 2=displaced 3=leaning forward slightly 4=collapsed 5=damaged	3							
11	Technique of inscription: 1 = incised 2 = carved in relief 3 = cast in relief 4 = lead letters 5 = painted	1							
12	Condition of inscription 1 = very good 2 = clear 3 = worn but decipherable 4 = partly legible 5 = illegible	3							
13	Dimensions (metric)	height	1	3	4	0			
		width		7	0	0			
		Thickness (or length in case of tombs)			8	5			
14	Date of memorial	1769 +	Register GAWEN (sic) SHOTTER bu. 9 "June" 1769						
<i>(NB Surrounding entries in register indicate that the month should be "July"; baptism not</i>									
<i>Sarah d. of GAWEN SHOTTER bu. 8 July 1740 // found 1702 -1706 -parts difficult to read)</i>									
Drawing or Photograph					Inscription				

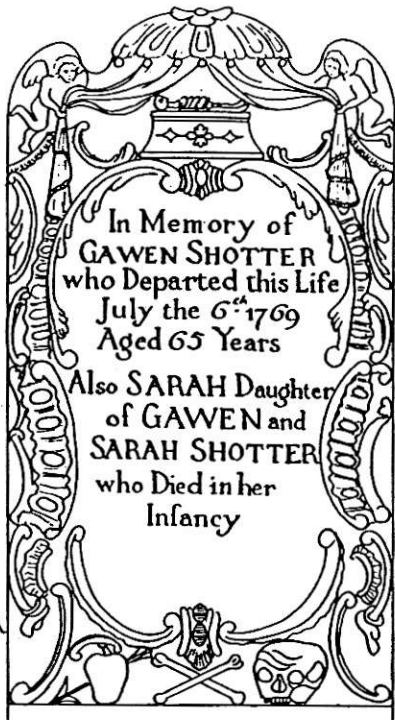

In Memory of
GAWEN SHOTTER
 who Departed this Life
 July the 6th 1769
 Aged 65 Years

[?6]

Also SARAH Daughter
 of GAWEN and
SARAH SHOTTER
 who Died in her
 Infancy

Grave Memorial Recording Form: St. John the Baptist, Westbourne, W. Sussex

1	National Grid Reference	755 073	Date	2	9	0	7	0	0
2	Name of recorder(s)	Benjamin Olive-Jones							
3	Record No. of memorial (plus components I,II,III etc.)	N	E	B		2	2	2	
4	No. of components or inscribed faces (record on reverse if possible)								
5	Type of memorial: 1 = flat 2 = head 3 = tomb 4 = foot 5 = tablet 6 = other	2							
6	Material and geology	Limestone	Sperling's record no. 37						
7	Stone mason or undertaker	not found							
8	Which surfaces inscribed (facing N, S, E or W)								W
9	No. of people commemorated								1
10	Condition of monument: 1=sound 2=displaced 3=leaning 4=collapsed 5=damaged								1
11	Technique of inscription: 1 = incised 2 = carved in relief 3 = cast in relief 4 = lead letters 5 = painted								1
12	Condition of inscription 1 = very good 2 = clear 3 = worn but decipherable 4 = partly legible 5 = illegible								2
13	Dimensions (metric)	height	6	7	5	width	5	8	5
		Thickness (or length in case of tombs)		9	0				
14	Date of memorial	1733+	Register	Mary da th Will ^m & Elizabeth Crockford bu 8 March 1733					
Drawing or Photograph					Inscription				

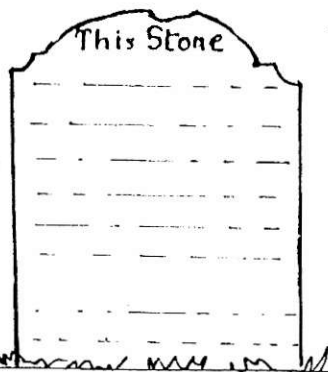

This Stone
 is in MEMORY of ~
 Mary Daughter of W^m
 & Elizabeth CROCKFORD
 Who died March the 6th
 1733 in ^e 19th Year of
 her AGE
 DEAR parents do not griev^{us} for
 for we are happy with the Just

Upper and lower case letters
 are thus.

Grave Memorial Recording Form: St. John the Baptist, Westbourne, W. Sussex

1	National Grid Reference	755 073	Date	2	4	0	7	0	0
2	Name of recorder(s)	June Marshall							
3	Record No. of memorial (plus components i,ii,iii etc.)	N	E	B		2	2	3	
4	No. of components or inscribed faces (record on reverse if possible)								
5	Type of memorial: 1 = flat 2 = head 3 = tomb 4 = foot 5 = tablet 6 = other								
6	Material and geology	Limestone							
7	Stone mason or undertaker	none found							
8	Which surfaces inscribed (facing N, S, E or W)								W
9	No. of people commemorated								
10	Condition of monument: 1=sound 2=displaced 3=leaning 4=collapsed 5=damaged								
11	Technique of inscription: 1 = incised 2 = carved in relief 3 = cast in relief 4 = lead letters 5 = painted								
12	Condition of inscription 1 = very good 2 = clear 3 = worn but decipherable 4 = partly legible 5 = illegible								
13	Dimensions (metric)	height	6	8	5	width	6	3	5
		Thickness (or length in case of tombs)		9	0				
14	Date of memorial	1754 +	Register	William Crockford bu. 3 Mar. 1754					
Drawing or Photograph					Inscription				

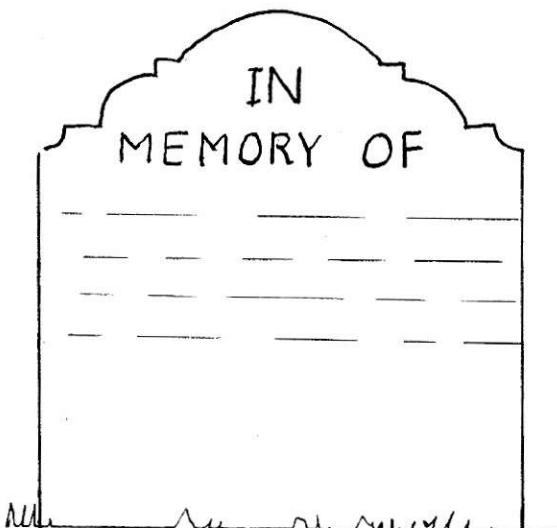

IN
 MEMORY OF
 WILLIAM CROCKFORD
 Senor Who Departed
 this Life February 28th
 1754 Aged 68 Years

Senor sic

Grave Memorial Recording Form: St. John the Baptist, Westbourne, W. Sussex

1	National Grid Reference	755 073	Date	0	1	0	8	0	0
2	Name of recorder(s)	June Marshall							
3	Record No. of memorial (plus components i,ii,iii etc.)	N	E	B			2	2	4
4	No. of components or inscribed faces (record on reverse if possible)								
5	Type of memorial: 1 = flat 2 = head 3 = tomb 4 = foot 5 = tablet 6 = other	2							
6	Material and geology	Limestone							
7	Stone mason or undertaker	Not known							
8	Which surfaces inscribed (facing N, S, E or W)	W							
9	No. of people commemorated	3							
10	Condition of monument: 1=sound 2=displaced 3=leaning (some pitting on surface) 4=collapsed 5=damaged	1							
11	Technique of inscription: 1 = incised 2 = carved in relief 3 = cast in relief 4 = lead letters 5 = painted	1							
12	Condition of Inscription 1 = very good 2 = clear 3 = worn but decipherable 4 = partly legible 5 = illegible	3							
13	Dimensions (metric)	height	1	3	0	0			
		width		7	2	5			
		Thickness (or length in case of tombs)			7	0			
14	Date of memorial	1825	Register Rebecca Ayling, Leigh, bu. 28 Oct. 1825						
			Robert Ayling, Printhead, bu. 21 Apr. 1827 a. 16 // a. 66						
			William Ayling, East Leigh, Havant, bu. 15 Dec. 1828 a. 19						
	Drawing or Photograph	Inscription							

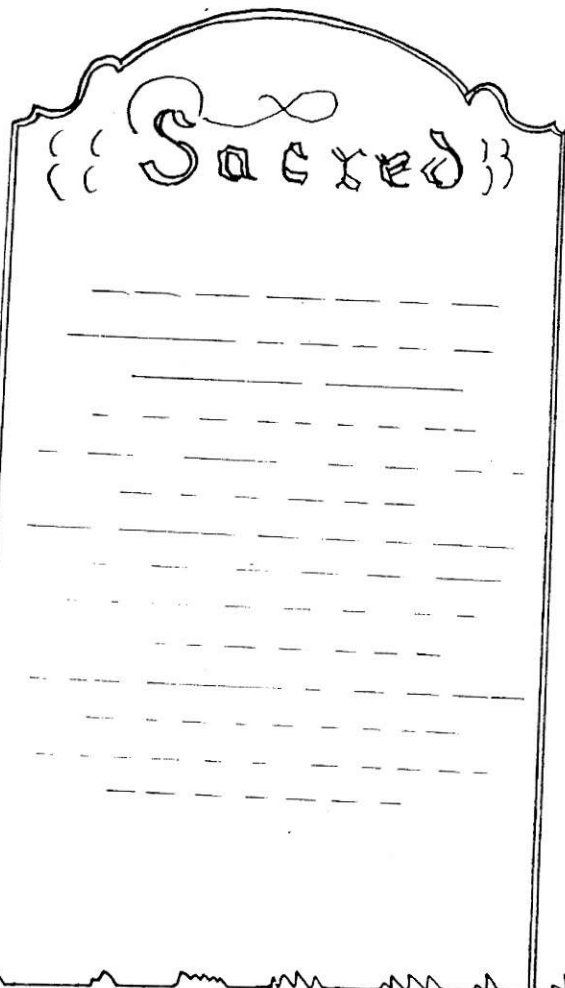

{{ Sacred. }}

to the Memory of
 REBECCA, Wife of
 JOHN AYLING
 who departed this Life
 the 26th of October 1825
 Aged [?] Years
 ** Also ROBERT, Son of the above
 who departed this Life
 the 18th of April 1827
 Aged 17. Years
 Also WILLIAM, Son of the above
 who departed this Life
 * the 1[?]th of December 1828
 Aged 19 Years

* apparently 18, could be 13 or 15.
 ** discrepancy with register in Rebecca's age

Grave Memorial Recording Form: St. John the Baptist, Westbourne, W. Sussex

1	National Grid Reference	755 073	Date	2	5	0	7	0	0
2	Name of recorder(s)	JOSEPHINE HALLETT							
3	Record No. of memorial (plus components i,ii,iii etc.)	N	E	B		2	2	5	
4	No. of components or inscribed faces (record on reverse if possible)								
5	Type of memorial: 1 = flat 2 = head 3 = tomb 4 = foot 5 = tablet 6 = other	2							
6	Material and geology	LIMESTONE							
7	Stone mason or undertaker	NONE FOUND							
8	Which surfaces inscribed (facing N, S, E or W)	W							
9	No. of people commemorated	1							
10	Condition of monument: 1=sound 2=displaced 3=leaning 4=collapsed 5=damaged	1							
11	Technique of inscription: 1 = incised 2 = carved in relief 3 = cast in relief 4 = lead letters 5 = painted	1							
12	Condition of inscription 1 = very good 2 = clear 3 = worn but decipherable 4 = partly legible 5 = illegible	2							
13	Dimensions (metric)	height	1	2	9	5			
		width		7	0	5			
		Thickness (or length in case of tombs)			6	5			
14	Date of memorial	1856 +	Register	James Elsegood Griffin, Emsworth bu. 26 Sept 1856 age 17					
Drawing or Photograph					Inscription				

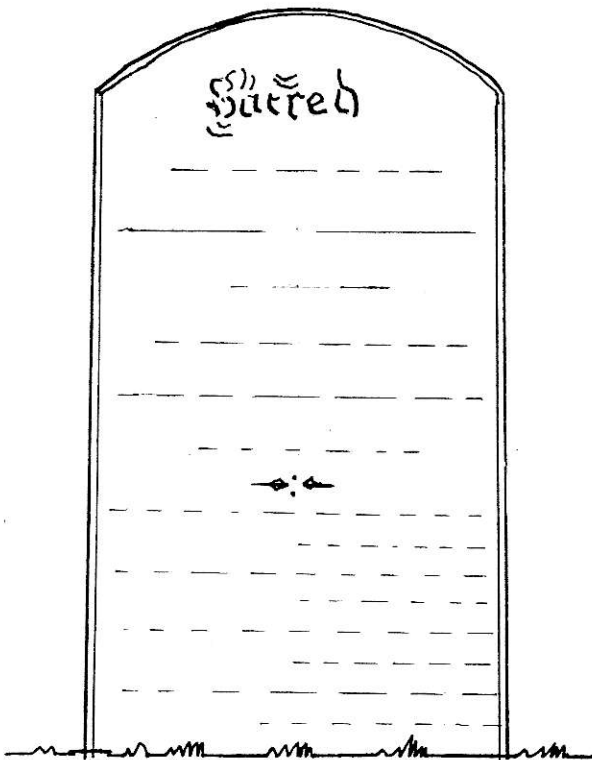

Sacred

TO THE MEMORY OF
 JAMES ELSEGOOD
 GRIFFIN.
 who departed this life .
 the 22nd of September 1856 .
 Aged 17 Years

◆:◆

Dearly lov'd ones, I must leave you,
 Mourn not for me .
 Let not my departure grieve you,
 Mourn not for me.
 On redeeming grace relying, Satan
 Death and doubt defying,
 Looking unto Christ, I'm dying,
 Mourn not for me.

Grave Memorial Recording Form: St. John the Baptist, Westbourne, W. Sussex

1	National Grid Reference	755 073	Date	2	5	0	7	0	0
2	Name of recorder(s)	DAPHNE COOPER							
3	Record No. of memorial (plus components i,ii,iii etc.)	N	E	B		2	2	6	
4	No. of components or inscribed faces (record on reverse if possible)								1
5	Type of memorial: 1 = flat 2 = head 3 = tomb 4 = foot 5 = tablet 6 = other								2
6	Material and geology	LIMESTONE							
7	Stone mason or undertaker	NONE FOUND							
8	Which surfaces inscribed (facing N, S, E or W)								W
9	No. of people commemorated								2
10	Condition of monument: 1=sound 2=displaced 3=leaning 4=collapsed 5=damaged								1
11	Technique of inscription: 1 = incised 2 = carved in relief 3 = cast in relief 4 = lead letters 5 = painted								1
12	Condition of inscription 1 = very good 2 = clear 3 = worn but decipherable 4 = partly legible 5 = illegible								2
13	Dimensions (metric)	height	1	2	7	0			
		width		6	7	0			
		Thickness (or length in case of tombs)			6	0			
14	Date of memorial	1856+	Register George Griffin, Portsea, bu. 27 Jan.						
		John Griffin, Emsworth,	bu. 10 Mar. 1856, a. 95//				// 1823, a. 22		
		formerly of this parish.							
	Drawing or Photograph	Inscription							

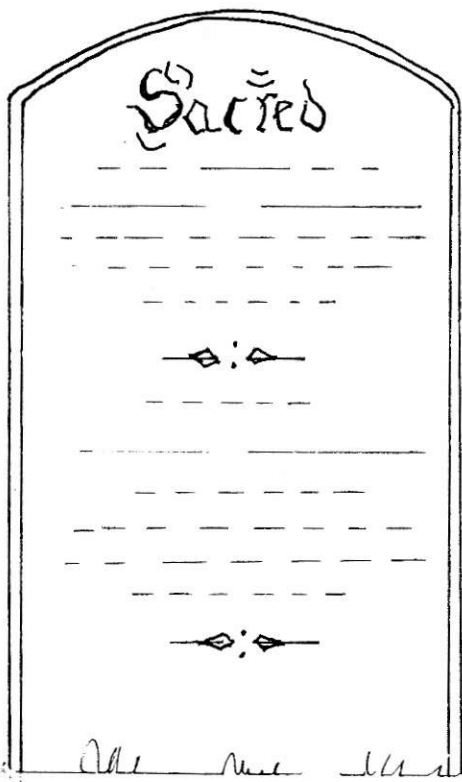

Sacred
 TO THE MEMORY OF
 JOHN GRIFFIN.
 who departed this life,
 the 4th of March 1856.
 Aged 95 Years.
 —♦—
 Also of
 GEORGE GRIFFIN
 SON OF THE ABOVE:
 who departed this life
 the 22nd of January 1823
 Aged 22 Years
 —♦—

Grave Memorial Recording Form: St. John the Baptist, Westbourne, W. Sussex

1	National Grid Reference	755 073	Date	1	6	0	5	0	1
2	Name of recorder(s)	DAPHNE COOPER							
3	Record No. of memorial (plus components i,ii,iii etc.)	N	E	B		2	2	7	
4	No. of components or inscribed faces (record on reverse if possible)								
5	Type of memorial: 1 = flat 2 = head 3 = tomb 4 = foot 5 = tablet 6 = other	2							
6	Material and geology	LIMESTONE							
7	Stone mason or undertaker	NONE FOUND							
8	Which surfaces inscribed (facing N, S, E or W)	W							
9	No. of people commemorated	2							
10	Condition of monument: 1=sound 2=displaced 3=leaning 4=collapsed 5=damaged	3							
11	Technique of inscription: 1 = incised 2 = carved in relief 3 = cast in relief 4 = lead letters 5 = painted	1							
12	Condition of inscription 1 = very good 2 = clear 3 = worn but decipherable 4 = partly legible 5 = illegible	2							
13	Dimensions (metric)	height	1	2	0	0			
		width		6	4	0			
		Thickness (or length in case of tombs)			6	5			
14	Date of memorial	1856+	Register	Sophia Knight, Ellbridge,					
		Emily Knights, Ellbridge, bu. 3 Nov, 1856, a. 13 //						bu. 11 July 1856 a. 42	
Drawing or Photograph					Inscription				



Sacred

TO THE MEMORY OF
SOPHIA, wife of
JOSEPH KNIGHT
who died July the 6th 1856.
Aged 23 Years

Also of EMILY.
daughter of the above
who died Nov^r the 21st 1856
Aged 13 Years.

Grave Memorial Recording Form: St. John the Baptist, Westbourne, W. Sussex

1	National Grid Reference	755 073	Date	0	8	0	8	0	0
2	Name of recorder(s)	JOSEPHINE HALLETT							
3	Record No. of memorial (plus components i,ii,iii etc.)	N	E	B		2	2	8	
4	No. of components or inscribed faces (record on reverse if possible)								
5	Type of memorial: 1 = flat 2 = head 3 = tomb 4 = foot 5 = tablet 6 = other	2							
6	Material and geology	LIMESTONE							
7	Stone mason or undertaker	NONE FOUND							
8	Which surfaces inscribed (facing N, S, E or W)								W
9	No. of people commemorated	3							
10	Condition of monument: 1=sound 2=displaced 3=leaning 4=collapsed 5=damaged	1							
11	Technique of inscription: 1 = incised 2 = carved in relief 3 = cast in relief 4 = lead letters 5 = painted	1							
12	Condition of inscription 1 = very good 2 = clear 3 = worn but decipherable 4 = partly legible 5 = illegible	3							
13	Dimensions (metric)	height	1	2	7	0			
		width		6	6	0			
		Thickness (or length in case of tombs)			6	5			
14	Date of memorial	1832+	Register Thomas Knight, Westbourne,						
			Phoebe Knight, Westbourne, bu. 16 Jan., 1834, a. 12 // // bu. 19 July, 1832, a. 49						
			Sarah Knight, Westbourne, bu. 29 Aug. 1843, a. 59						
	Drawing or Photograph	Inscription							

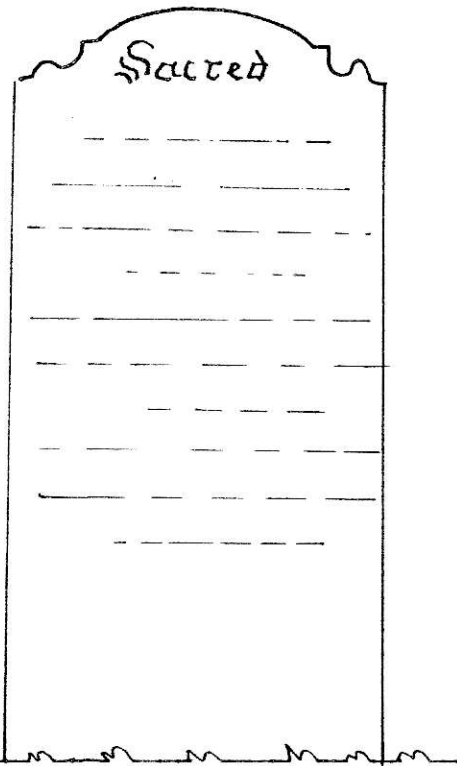

Sacred
to the Memory of
THOMAS KNIGHT
who Died the 19th of July 1832
Aged 49 Years.
Also SARAH Wife of the above
who Died the 23rd August 1843
Aged 59 Years.
PHOEBE Daughter of the above.
who Died the 16th of January 1834
Aged 12 Years.

Grave Memorial Recording Form: St. John the Baptist, Westbourne, W. Sussex

1	National Grid Reference	755 073	Date	0	7	0	8	0	1
2	Name of recorder(s)	KEITH LINDER							
3	Record No. of memorial (plus components i,ii,iii etc.)	N	E	B		2	2	9	
4	No. of components or inscribed faces (record on reverse if possible)								
5	Type of memorial: 1 = flat 2 = head 3 = tomb 4 = foot 5 = tablet 6 = other	CROSS & PLINTH							
6	Material and geology	GRANITE							
7	Stone mason or undertaker	NONE FOUND							
8	Which surfaces inscribed (facing N, S, E or W)	N	S	E					
9	No. of people commemorated	5 5							
10	Condition of monument: 1=sound 2=displaced 3=leaning 4=collapsed 5=damaged	1							
11	Technique of inscription: 1 = incised 2 = carved in relief 3 = cast in relief 4 = lead letters 5 = painted	4							
12	Condition of inscription 1 = very good 2 = clear 3 = worn but decipherable 4 = partly legible 5 = illegible	1							
13	Dimensions (metric)	height	3	2	6	0			
		width	1	0	6	5			
		Thickness (or length in case of tombs)		7	1	0			
14	Date of memorial	1919 +	Register						

Drawing or Photograph

Inscription

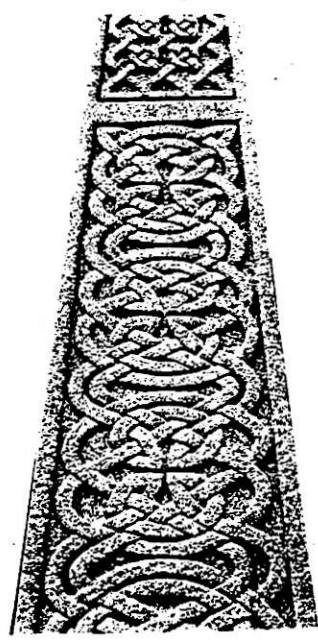
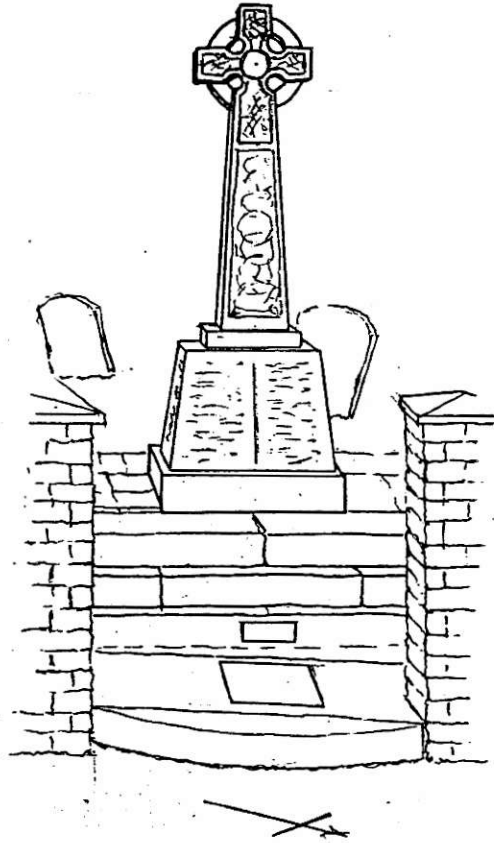

SEE OVER

East Face:

IN MEMORY OF MEN FROM WESTBOURNE,
WHO LAID DOWN THEIR LIVES IN
THE GREAT WAR 1914-1919

W.ADAMS, ROYAL SUSSEX.
E.P.CHAMBERLAIN, R.N.
R.COVIINGTON, ROYAL ENGINEERS.
T.COUSINS, HANTS REG^L
H.T.GILBERT, H.M.S.BLACK PRINCE.
C.E.GOUGH, DORSET REG^L.
T.GRIFFITH, H.M.S. ABOUKIR.
N.HULL, ROYAL SUSSEX.
R.J.KENNARD, HANTS REG^L.
J.LANGLEY, R.F.A.
2NDLIEUT.G.H.MERRIKIN, LONDON REG^L.
J.MONK, ROYAL FUSILIERS.
C.NASH, SUBMARINE C31.
P.G.PORTER, HANTS REG^L.
T.PHILLIPS, H.M.S.BULWARK.

E.BOORNE, WORCESTERSHIRE.
C.J.COLLINS, H.M.S.GOOD HOPE.
E.CROUCH, H.M.S.BULWARK.
L.C.ELIAS, AUSTRALIAN CONTINGENT.
F.A.GLADDEN, NORFOLK REG^L.
A.GREEN, EAST SURREY.
E.HAMILTON, ROYAL SUSSEX.
W.H.HARRISON, H.M.S.ARIEL.
R.KEMP, HANTS REG^L.
H.R.MARCHANT, R.F.A.
A.MARSH, ROYAL SUSSEX.
W.NEWELL, H.M.S.BULWARK.
W.PILES, HANTS REG^L.
J.PORTSMOUTH, A.&S.H^{RS}.
F.PHILLIPS, H.M.S.GHURKA.

"GREATER LOVE HATH NO MAN THAN THIS, THAT A MAN LAY DOWN HIS LIFE FOR HIS FRIENDS"

South Face:

F.C.PARSONS, K.O.Y.L.I.
G.W.RICHARDSON, HANTS REG^L.
C.J.SOUTER, H.M.S.GOOD HOPE.
W.SELSBY, H.M.S.QUEEN MARY.
P.SMITH, H.M.S.MALAYA.
H.STENT, R.G.A.
G.STEVENS, QUEENS REG^L.
A.STILLWELL, ROYAL SUSSEX.
A.SMITH, H.M.S.AGINCOURT.
S.E.SULLY, R.A.S.C.
LIEUT.G.T.F.TOTHILL, ROYAL FUSILIERS.
C.TEE, H.M.S.INVINCIBLE.
P.TEE, ROYAL FUSILIERS.
A.TILBURY, ROYAL SUSSEX.
LIEUT.J.S.BINNEY SCOTT, SUBMARINE E3.

North Face:

G.TRUDGETT, ROYAL WARWICKS.
F.TILL, R.A.S.C.
A.VOICE, ROYAL SUSSEX.
B.WELLS, H.M.S.QUEEN MARY.
F.WELLS, R.M.L.I.
C.H.C.WEST, AUSTRALIAN CONTINGENT
J.WEST, H.M.S.COLIN BELLA.
L.WHITAKER, HANTS REG^L.
H.WAKEFORD, ROYAL SUSSEX.
ENG^LCOMD^LJ.B.WILSHIN, H.M.S.MONMOUTH

(Sperling's record no. *N/A*...)

Grave Memorial Recording Form: St. John the Baptist, Westbourne, W. Sussex

1	National Grid Reference	755 073	Date	0	7	0	8	0	1
2	Name of recorder(s)	KEITH LINDER							
3	Record No. of memorial (plus components i,ii,iii etc.)	N	E	B		2	3	0	
4	No. of components or inscribed faces (record on reverse if possible)								
5	Type of memorial: 1 = flat 2 = head 3 = tomb 4 = foot 5 = tablet 6 = other								
6	Material and geology	STONE: LIMESTONE							
7	Stone mason or undertaker	NONE FOUND							
8	Which surfaces inscribed (facing N, S, E or W)	N/A							
9	No. of people commemorated	29							
10	Condition of monument: 1=sound 2=displaced 3=leaning 4=collapsed 5=damaged								
11	Technique of inscription: 1 = incised 2 = carved in relief 3 = cast in relief 4 = lead letters 5 = painted								
12	Condition of inscription 1 = very good 2 = clear 3 = worn but decipherable 4 = partly legible 5 = illegible								
13	Dimensions (metric)	height	6	4	0				
		width	5	1	5				
		Thickness (or length in case of tombs)	/	/	/				
14	Date of memorial	1977 +	Register						
	(See memorial to Rear Admiral Langworthy)								
	(no. 231)								
Drawing or Photograph					Inscription				

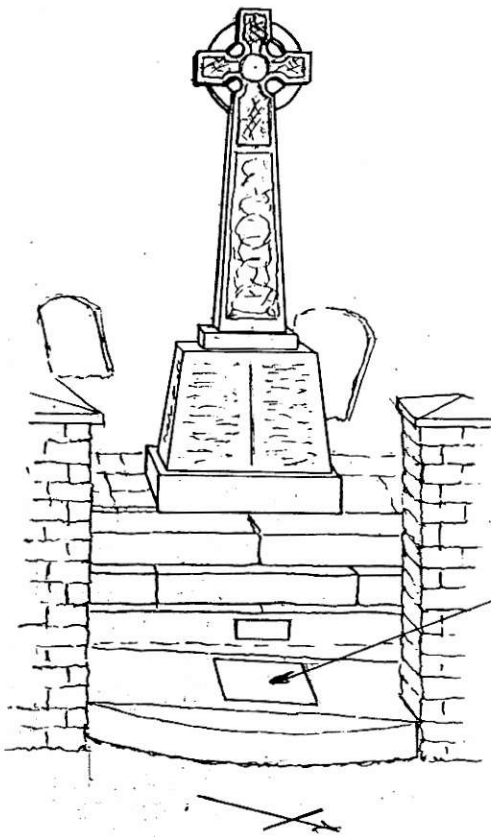

- 1939 - 1945
- | | |
|-----------------------------------|-------------------------------|
| K. ATKINSON | L. GILLARD |
| A. AYLWARD | F. HARRISON |
| D. BADCOCK | A. KNIGHT |
| G. BAILEY | P. LASHLY |
| G. BEASLEY | J. McCRAE |
| A. BOYNS | R. PHILLIPS |
| F. CONSTABLE | W. PRYKE |
| C. DENHAM | A. ROBINSON |
| E. FARNDEN | C. ROBINSON |
| A. FARMER | R. ROBINSON _{d.s.m.} |
| C. FOSSEY | W. SOLE |
| W. GARDNER | W. SYLVESTER |
| T. GODWIN | E. TUTT |
| D. GREGORY | R. WEST |
| R. GORDON-SMITH _{d.s.c.} | |

Grave Memorial Recording Form: St. John the Baptist, Westbourne, W. Sussex

1	National Grid Reference <i>755 073</i>	Date	0	7	0	8	0	1	
2	Name of recorder(s) <i>KEITH LINDER</i>								
3	Record No. of memorial (plus components I,II,III etc.)						<i>2</i>	<i>3</i>	
4	No. of components or inscribed faces (record on reverse if possible)							<i>1</i>	
5	Type of memorial: 1 = flat 2 = head 3 = tomb 4 = foot 5 = tablet 6 = other <i>BRASS PLATE</i>								<i>6</i>
6	Material and geology <i>bronze</i>								
7	Stone mason or undertaker								
8	Which surfaces inscribed (facing N, S, E or W)								
9	No. of people commemorated								
10	Condition of monument: 1=sound 2=displaced 3=leaning 4=collapsed 5=damaged								<i>1</i>
11	Technique of inscription: 1 = incised 2 = carved in relief 3 = cast in relief 4 = lead letters 5 = painted								<i>1</i>
12	Condition of inscription 1 = very good 2 = clear 3 = worn but decipherable 4 = partly legible 5 = illegible								<i>1</i>
13	Dimensions (metric)						height	<i>1</i>	<i>0</i>
							width	<i>1</i>	<i>5</i>
							Thickness (or length in case of tombs)	<i>/</i>	<i>/</i>
14	Date of memorial <i>1977 +</i>				Register				
Drawing or Photograph					Inscription				

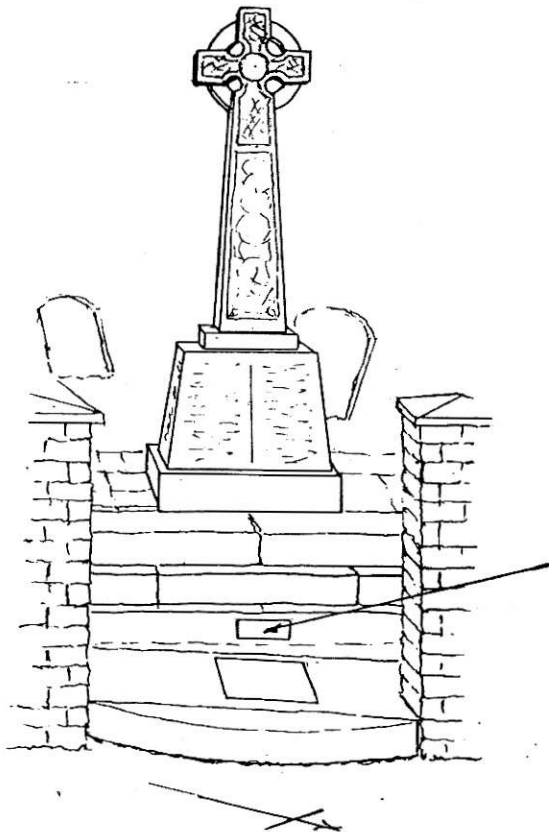

THE 1939-1945 MEMORIAL

was given in memory of

Rear Admiral

CECIL RAMSDEN LANGWORTHY PARRY

CB DSO

1901-1977

Grave Memorial Recording Form: St. John the Baptist, Westbourne, W. Sussex

1	National Grid Reference	755 073	Date	2	5	0	7	0	0
2	Name of recorder(s)	BERYL LINDER							
3	Record No. of memorial (plus components i,ii,iii etc.)	N	E	B		2	3	2	
4	No. of components or inscribed faces (record on reverse if possible)								
5	Type of memorial: 1 = flat 2 = head 3 = tomb 4 = foot 5 = tablet 6 = other	set in paving round War Memorial							
6	Material and geology	LIMESTONE: PORTLAND TYPE							
7	Stone mason or undertaker	NONE FOUND							
8	Which surfaces inscribed (facing N, S, E or W)	N/A							
9	No. of people commemorated								
10	Condition of monument: 1=sound 2=displaced 3=leaning 4=collapsed 5=damaged	2 5							
11	Technique of inscription: 1 = incised 2 = carved in relief 3 = cast in relief 4 = lead letters 5 = painted	1							
12	Condition of inscription 1 = very good 2 = clear 3 = worn but decipherable 4 = partly legible 5 = illegible	2							
13	Dimensions (metric)	height	6	6	0	width	3	4	0
		Thickness (or length in case of tombs)							
14	Date of memorial	1847+	Register						

Drawing or Photograph

Inscription

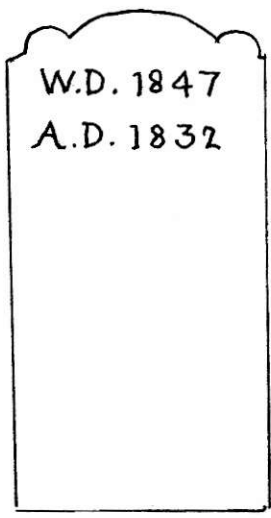

William and Ann Day
(headstone no. NEB 244)

Grave Memorial Recording Form: St. John the Baptist, Westbourne, W. Sussex

1	National Grid Reference	755 073	Date	2	5	0	7	0	0
2	Name of recorder(s)	BERYL LINDER							
3	Record No. of memorial (plus components i,ii,iii etc.)	N	E	B		2	3	3	
4	No. of components or inscribed faces (record on reverse if possible)								
5	Type of memorial: 1 = flat 2 = head 3 = tomb 4 = foot 5 = tablet 6 = other	re-used in paving, War Memorial 4							
6	Material and geology	LIMESTONE							
7	Stone mason or undertaker	NONE FOUND							
8	Which surfaces inscribed (facing N, S, E or W)	X/A	/	/	/	/	/	/	/
9	No. of people commemorated								
10	Condition of monument: 1=sound 2=displaced 3=leaning 4=collapsed 5=damaged	2 5							
11	Technique of inscription: 1 = incised 2 = carved in relief 3 = cast in relief 4 = lead letters 5 = painted	1							
12	Condition of inscription 1 = very good 2 = clear 3 = worn but decipherable 4 = partly legible 5 = illegible	4							
13	Dimensions (metric)	height		6	6	0			
		width		3	8	0			
		Thickness (or length in case of tombs)	/	/	/	/	/	/	/
14	Date of memorial ? 1738	Register							
Drawing or Photograph					Inscription				



Perhaps footstone to Sperling no. 143
Thomas Hurst 1738 which is
poss. our OR 658 fragment

Grave Memorial Recording Form: St. John the Baptist, Westbourne, W. Sussex

1	National Grid Reference	755 073	Date	2	7	0	7	0	0
2	Name of recorder(s)	BERYL LINDER							
3	Record No. of memorial (plus components i,ii,iii etc.)	N	E	B		2	3	4	
4	No. of components or inscribed faces (record on reverse if possible)								
5	Type of memorial: 1 = flat 2 = head 3 = tomb 4 = foot 5 = tablet 6 = other	set in paving round War Memorial							
6	Material and geology	LIMESTONE : PORTLAND TYPE							
7	Stone mason or undertaker	NONE FOUND							
8	Which surfaces inscribed (facing N, S, E or W)	N/A							
9	No. of people commemorated								
10	Condition of monument: 1=sound 2=displaced 3=leaning 4=collapsed 5=damaged	2 5							
11	Technique of inscription: 1 = incised 2 = carved in relief 3 = cast in relief 4 = lead letters 5 = painted								
12	Condition of inscription 1 = very good 2 = clear 3 = worn but decipherable 4 = partly legible 5 = illegible	3							
13	Dimensions (metric)	height	6	6	0				
		width	3	0	0				
		Thickness (or length in case of tombs)	/	/	/				
14	Date of memorial	1845 +	Register						
Drawing or Photograph					Inscription				

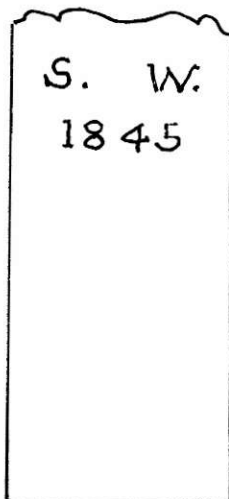

(Sophia Wright; headstone no NEB 24)

Grave Memorial Recording Form: St. John the Baptist, Westbourne, W. Sussex

1	National Grid Reference	755 073	Date	2	5	0	7	0	0		
2	Name of recorder(s)	BERYL LINDER									
3	Record No. of memorial (plus components i,ii,iii etc.)	N		E		B		2	3	5	
4	No. of components or inscribed faces (record on reverse if possible)									1	
5	Type of memorial: 1 = flat 2 = head 3 = tomb 4 = foot 5 = tablet 6 = other	re-used in paving round War Memorial								4	
6	Material and geology	LIMESTONE									
7	Stone mason or undertaker	NONE FOUND									
8	Which surfaces inscribed (facing N, S, E or W)	N/A <input checked="" type="checkbox"/> <input checked="" type="checkbox"/> <input checked="" type="checkbox"/> <input checked="" type="checkbox"/>									
9	No. of people commemorated									1	
10	Condition of monument: 1=sound 2=displaced 3=leaning 4=collapsed 5=damaged									2	5
11	Technique of inscription: 1 = incised 2 = carved in relief 3 = cast in relief 4 = lead letters 5 = painted										1
12	Condition of inscription 1 = very good 2 = clear 3 = worn but decipherable 4 = partly legible 5 = illegible										3
13	Dimensions (metric)	height		6		6		0			
		width		3		6		0			
		Thickness (or length in case of tombs)		/		/		/			
14	Date of memorial	1860		Register							
Drawing or Photograph					Inscription						

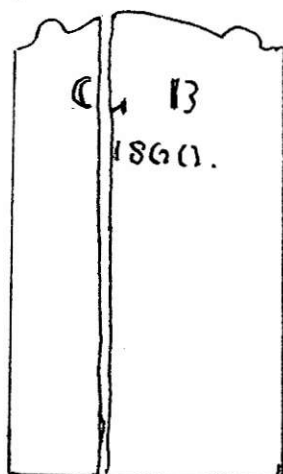

Probably George Bowman 1860, S.E 4

Grave Memorial Recording Form: St. John the Baptist, Westbourne, W. Sussex

1	National Grid Reference	755 073	Date	1	5	0	8	0	0
2	Name of recorder(s)	BERYL LINDER							
3	Record No. of memorial (plus components i,ii,iii etc.)	N	E	B		2	3	6	ii
4	No. of components or inscribed faces (record on reverse if possible)								
5	Type of memorial: 1 = flat 2 = head 3 = tomb 4 = foot 5 = tablet 6 = other								
6	Material and geology	LIMESTONE, with some sandy portions							
7	Stone mason or undertaker	NONE FOUND							
8	Which surfaces inscribed (facing N, S, E or W)	N S							
9	No. of people commemorated	2							
10	Condition of monument: 1=sound 2=displaced 3=leaning 4=collapsed 5=damaged	1							
11	Technique of inscription: 1 = incised 2 = carved in relief 3 = cast in relief 4 = lead letters 5 = painted	1							
12	Condition of inscription 1 = very good 2 = clear 3 = worn but decipherable 4 = partly legible 5 = illegible	3							
13	Dimensions (metric)	height	3	0	0	width	6	0	0
		Thickness (or length in case of tombs)	1	8	0	0			
14	Date of memorial ? 1837 or 1849	Register Elizabeth Robbins; Westbourne George Robbins, Westbourne, bu. 21 Aug. 1849, a. 77 bu. 10 July 1837							
Drawing or Photograph					Inscription				

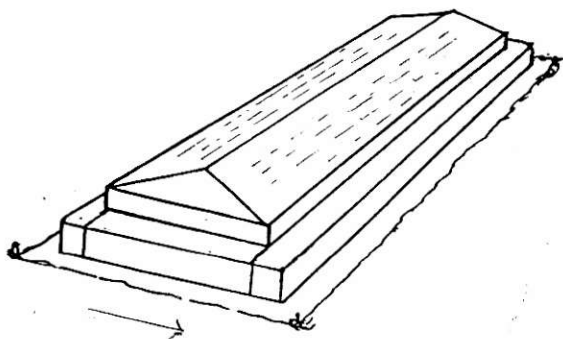

SACRED to the Memory of
 ELIZABETH the Wife of
 GEORGE ROBBINS
 who Died August 17 1849
 Aged 77 Years
 who Died July 12th 1837 Aged 73 Years

Grave Memorial Recording Form: St. John the Baptist, Westbourne, W. Sussex

1	National Grid Reference	755 073	Date		1		8	0	0	
2	Name of recorder(s)	SHIRLEY HARVEY - WHITING								
3	Record No. of memorial (plus components i,ii,iii etc.)	N E B				2	3	7		
4	No. of components or inscribed faces (record on reverse if possible)									
5	Type of memorial: 1 = flat 2 = head 3 = tomb 4 = foot 5 = tablet 6 = other	plus body stone							4	2
6	Material and geology	STONE								
7	Stone mason or undertaker	not found								
8	Which surfaces inscribed (facing N, S, E or W)									
9	No. of people commemorated									
10	Condition of monument: 1=sound 2=displaced 3=leaning 4=collapsed 5=damaged									
11	Technique of inscription: 1 = incised 2 = carved in relief 3 = cast in relief 4 = lead letters 5 = painted									
12	Condition of inscription 1 = very good 2 = clear 3 = worn but decipherable 4 = partly legible 5 = illegible									
13	Dimensions (metric)	height	1	4	0	0				
		width		6	6	0				
		Thickness (or length in case of tombs)			7				3	
14	Date of memorial	1831+	Register	John Cousins. Prinsted Lodge						
				bur 9th July 1831 Aged 74 years.						
Drawing or Photograph					Inscription					

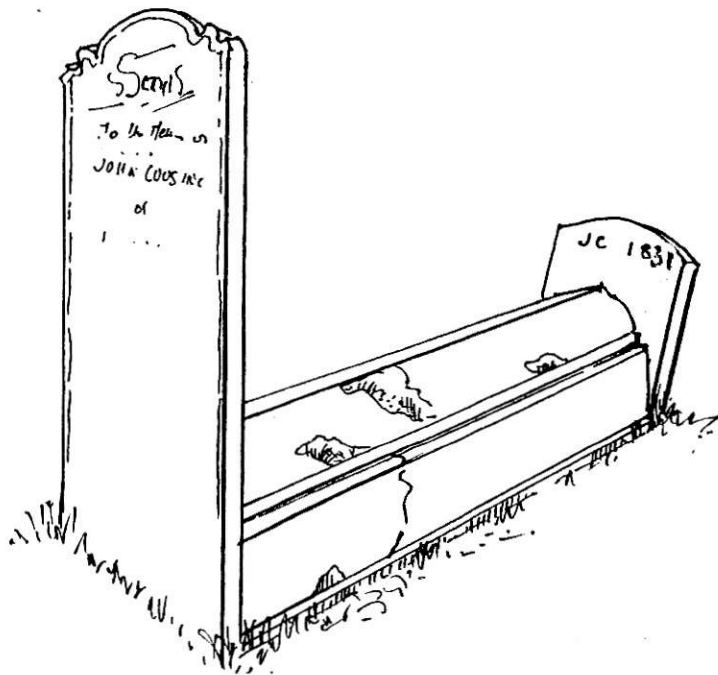

(i)

~~Secret~~

To the Memory of
 JOHN COUSINS
 of
 Prinsted Lodge
 who departed this Life
 the 4th day of July 1831
 aged 74 Years.

See over. Footstone & body slab

Foot Stone NEB 237 ii

h. 46 cms
 w. 53.5 cms
 d. 6.3 cms

faces W limestone

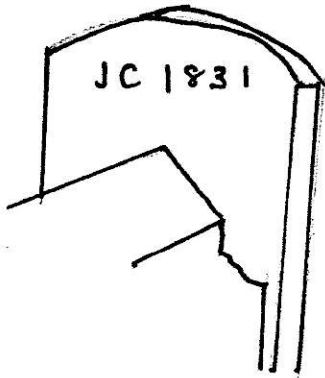
BODY SLAB iii

L. 183 cms
 W. 53.5 cms
 h. 36 cms.

Grave Memorial Recording Form: St. John the Baptist, Westbourne, W. Sussex

1	National Grid Reference	755 073	Date	0	8	0	8	0	0
2	Name of recorder(s)	Beryl Linden							
3	Record No. of memorial (plus components i,ii,iii etc.)	N E B		2	3	8			
4	No. of components or inscribed faces (record on reverse if possible)	1							
5	Type of memorial: 1 = flat 2 = head 3 = tomb 4 = foot 5 = tablet 6 = other	3							
6	Material and geology	LIMESTONE							
7	Stone mason or undertaker	NONE FOUND							
8	Which surfaces inscribed (facing N, S, E or W)	E							
9	No. of people commemorated	1							
10	Condition of monument: 1=sound 2=displaced 3=leaning 4=collapsed 5=damaged	large chips and a crack across						5	
11	Technique of inscription: 1 = incised 2 = carved in relief 3 = cast in relief 4 = lead letters 5 = painted	1							
12	Condition of inscription 1 = very good 2 = clear 3 = worn but decipherable 4 = partly legible 5 = illegible	4							
13	Dimensions (metric)	including plinth		height	3	0	0		
				width	7	8	0		
		Thickness (or length in case of tombs)		1	9	5	0		
14	Date of memorial	1843+ or 1858+	Register George Smith, Havant, bu. 2 Nov.						
		Joseph Smith, Emsworth, bu. 26 Aug. 1858, aged 27						1843 a-12	
Drawing or Photograph					Inscription				

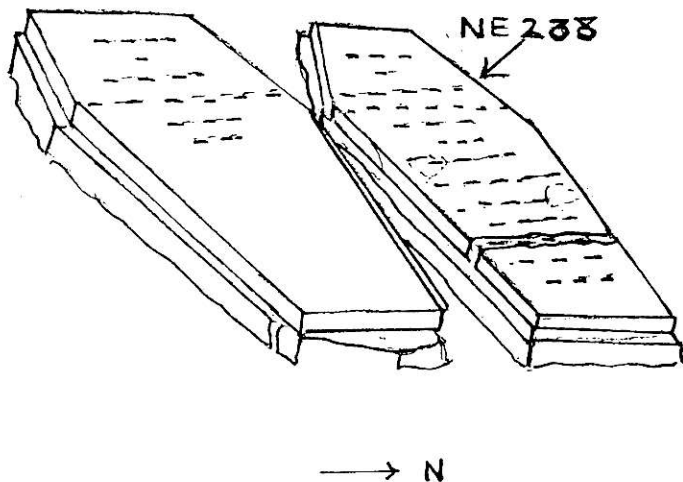

IN MEMORY
of
GEORGE SMITH Jun^r
who departed this Life
the 26th of October 1843
Aged 13 Years
[JOS] EPH SMITH
second son of the late
GEORGE SMITH E[sq.]
[who] was drowned in [Emsworth]
Harbour by the upsetting of a
Pleasure Boat on the 21st of
August 1858 Aged 27 Years

Two of the others who perished in this accident were George Shum Shear, also buried in Westbourne churchyard (no. NEB 203), and the Revd. Herbert Morse, curate of St. James's, Emsworth, who is buried in Warblington churchyard (no. SE 623 of the Warblington record). Morse is commemorated also by a tablet in St. James's Church.

acc. to Sperling, Joseph was a solicitor and second son of George, his no. 269, our 239

Grave Memorial Recording Form: St. John the Baptist, Westbourne, W. Sussex

1	National Grid Reference	755 073	Date	0	8	0	8	0	0
2	Name of recorder(s)	Beryl Linden							
3	Record No. of memorial (plus components i,ii,iii etc.)	N	E	B		2	3	9	
4	No. of components or inscribed faces (record on reverse if possible)								
5	Type of memorial: 1 = flat 2 = head 3 = tomb 4 = foot 5 = tablet 6 = other	3							
6	Material and geology	LIMESTONE							
7	Stone mason or undertaker	NONE FOUND							
8	Which surfaces inscribed (facing N, S, E or W)	E							
9	No. of people commemorated	2							
10	Condition of monument: 1=sound 2=displaced 3=leaning 4=collapsed 5=damaged	5							
11	Technique of inscription: 1 = incised 2 = carved in relief 3 = cast in relief 4 = lead letters 5 = painted	1							
12	Condition of inscription 1 = very good 2 = clear 3 = worn but decipherable 4 = partly legible 5 = illegible	3							
13	Dimensions (metric)	incl. plinth	height	3	0	0			
			width	7	6	0			
		Thickness (or length in case of tombs)	1	9	5	0			
14	Date of memorial	1838 +	Register	George Smith, Havant, bu. 14 May, 1838 a.47					
Drawing or Photograph					Inscription				

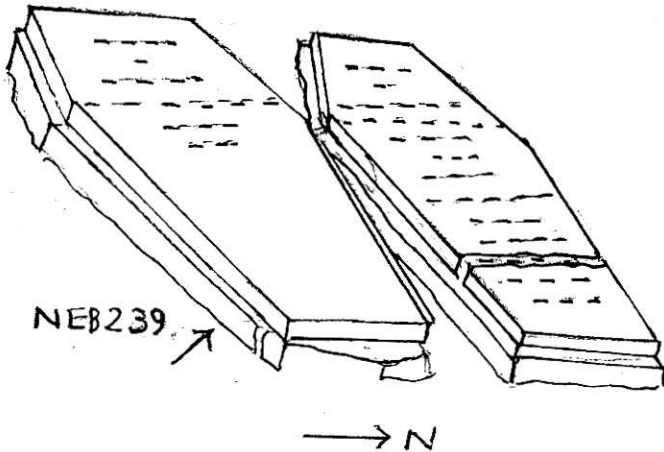

IN MEMORY
of
GEORGE SMITH Esq
who departed this Life
the 7th of May 1838
Aged 47 Years

acc. to Sperling the s. of this no. 268
the large tomb {our 247
Joseph Smith

Grave Memorial Recording Form: St. John the Baptist, Westbourne, W. Sussex

1	National Grid Reference	755 073	Date	1	5	0	8	0	0
2	Name of recorder(s)	JOSEPHINE HALLETT							
3	Record No. of memorial (plus components i,ii,iii etc.)	N	E	B		2	4	0	
4	No. of components or inscribed faces (record on reverse if possible)								
5	Type of memorial: 1 = flat 2 = head 3 = tomb 4 = foot 5 = tablet 6 = other								
6	Material and geology	LIMESTONE							
7	Stone mason or undertaker	NONE FOUND							
8	Which surfaces inscribed (facing N, S, E or W)								
9	No. of people commemorated								
10	Condition of monument: 1=sound 2=displaced 3=leaning 4=collapsed 5=damaged								
11	Technique of inscription: 1 = incised 2 = carved in relief 3 = cast in relief 4 = lead letters 5 = painted								
12	Condition of inscription 1 = very good 2 = clear 3 = worn but decipherable 4 = partly legible 5 = illegible								
13	Dimensions (metric)	height	1	1	7	5			
		width		6	5	5			
		Thickness (or length in case of tombs)			7	0			
14	Date of memorial	1847	Register	George Thomas Lyne, Westbourne, bu. 7 May 1847, a. 44					
Drawing or Photograph					Inscription				

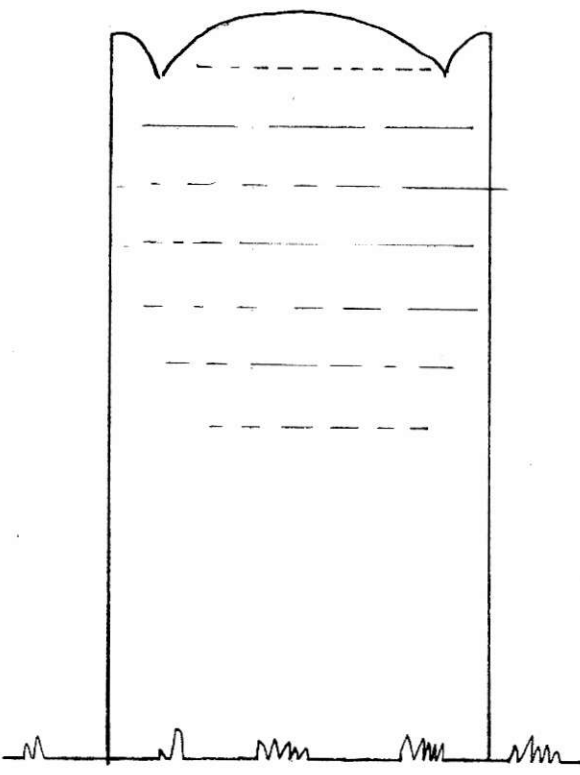

TO THE MEMORY OF
 GEORGE THOMAS LYNE
 SON OF CAPTAIN THOMAS
 AND ELIZABETH LYNE
 WHO DEPARTED THIS LIFE
 THE 2ND OF MAY 1847
 AGED 44 YEARS.

Footstone is no. NW 102B

Grave Memorial Recording Form: St. John the Baptist, Westbourne, W. Sussex

1	National Grid Reference	755 073	Date	1	5	8	0	0
2	Name of recorder(s)	SHIRLEY HARVEY-WHITING.						
3	Record No. of memorial (plus components i,ii,iii etc.)	N	E	B	2	4	1	
4	No. of components or inscribed faces (record on reverse if possible)							
5	Type of memorial: 1 = flat 2 = head 3 = tomb 4 = foot 5 = tablet 6 = other	2						
6	Material and geology	LIME STONE						
7	Stone mason or undertaker	None Found						
8	Which surfaces inscribed (facing N, S, E or W)	W						
9	No. of people commemorated	2						
10	Condition of monument: 1=sound 2=displaced 3=leaning 4=collapsed 5=damaged	1						
11	Technique of inscription: 1 = incised 2 = carved in relief 3 = cast in relief 4 = lead letters 5 = painted	1						
12	Condition of inscription 1 = very good 2 = clear 3 = worn but decipherable 4 = partly legible 5 = illegible	2						
13	Dimensions (metric)	height	1	1	8	0		
		width		7	0	0		
		Thickness (or length in case of tombs)			7	0		
14	Date of memorial 1848+	Register Elizabeth Lyne, Westbourne, Thomas Lyne, WB, bu. 4 Feb 1848 a.79 // bu. 29 Oct. 1832, a.56						
Drawing or Photograph			Inscription					

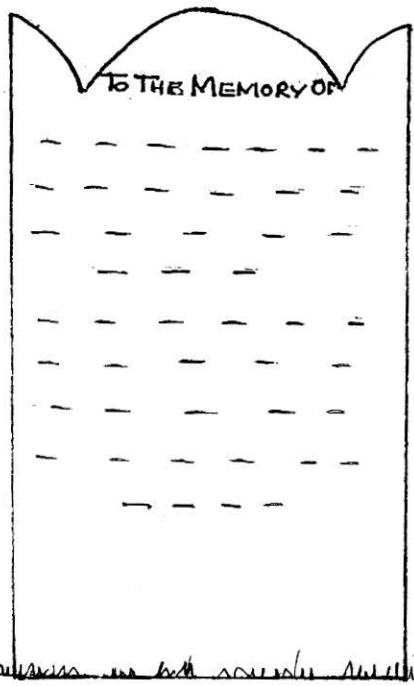

TO THE MEMORY OF
 CAPTAIN THOMAS LYNE.R.N.
 WHO DEPARTED THIS LIFE
 THE 1ST OF FEBRUARY 1848
 AGED 79 YEARS.
 ALSO OF ELIZABETH
 WIFE OF THE ABOVE
 WHO DEPARTED THIS LIFE
 THE 26 OF OCTOBER 1832
 AGED 56 YEARS

Grave Memorial Recording Form: St. John the Baptist, Westbourne, W. Sussex

1	National Grid Reference	755 073	Date	1	5	0	8	0	0	
2	Name of recorder(s)	BERYL LINDER								
3	Record No. of memorial (plus components I,II,III etc.)	N E B		2		4		2		
4	No. of components or inscribed faces (record on reverse if possible)									
5	Type of memorial: 1 = flat 2 = head 3 = tomb 4 = foot 5 = tablet 6 = other	2								
6	Material and geology	LIMESTONE								
7	Stone mason or undertaker	NONE FOUND								
8	Which surfaces inscribed (facing N, S, E or W)	W								
9	No. of people commemorated	2								
10	Condition of monument: 1=sound 2=displaced 3=leaning 4=collapsed 5=damaged	1								
11	Technique of inscription: 1 = incised 2 = carved in relief 3 = cast in relief 4 = lead letters 5 = painted	5 1								
12	Condition of inscription 1 = very good 2 = clear 3 = worn but decipherable 4 = partly legible 5 = illegible	1								
13	Dimensions (metric)	height	1	1	7	0	width	6	9	0
		Thickness (or length in case of tombs)			7	0				
14	Date of memorial	1828+	Register	Frances Lyne bu. 15 Aug. 1829, a. 18 Philip Lyne Lyne, Westbourne, bu 22 Oct. Oct 1853 a. 35 //						
Drawing or Photograph					Inscription					

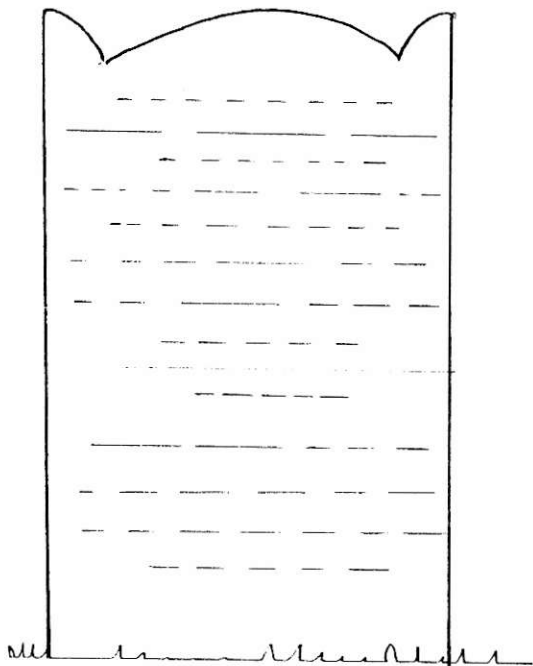

TO THE MEMORY OF
 FRANCES REBECCA LYNE
 DAUGHTER OF
 CAPTAIN THOMAS LYNE R.N.
 AND ELIZABETH LYNE
 SHE DEPARTED THIS LIFE
 THE 12TH OF AUGUST 1828
 AGED 18 YEARS
 ALSO OF
 PHILIP LYNE LYNE
 HE DEPARTED THIS LIFE
 THE 15TH OF OCTOBER 1853
 AGED 34 YEARS.

Below line 8 is a recessed section suggesting that the surface, perhaps bearing an epitaph, has been removed to allow Philip's inscription to be added.

Discrepancy in year of Frances's death: 1828 on headstone, but 1829 on footstone and in register.

Grave Memorial Recording Form: St. John the Baptist, Westbourne, W. Sussex

1	National Grid Reference	755 073	Date	1	5	0	8	0	0	
2	Name of recorder(s)	KEITH LINDER								
3	Record No. of memorial (plus components i,ii,iii etc.)	N		E		B		2	4	3
4	No. of components or inscribed faces (record on reverse if possible)									1
5	Type of memorial: 1 = flat 2 = head 3 = tomb 4 = foot 5 = tablet 6 = other									2
6	Material and geology	STONE: LIMESTONE								
7	Stone mason or undertaker	NONE FOUND								
8	Which surfaces inscribed (facing N, S, E or W)									W
9	No. of people commemorated									1
10	Condition of monument: 1=sound 2=displaced 3=leaning 4=collapsed 5=damaged									1
11	Technique of inscription: 1 = incised 2 = carved in relief 3 = cast in relief 4 = lead letters 5 = painted									1
12	Condition of inscription 1 = very good 2 = clear 3 = worn but decipherable 4 = partly legible 5 = illegible									3
13	Dimensions (metric)	height		1	0	8	0			
		width			6	6	0			
		Thickness (or length in case of tombs)				6	5			
14	Date of memorial	1845 +	Register Sophia Wright bu. 21 Aug 1845, aged 32, Hermitage Sophia d. William & Ann Day bap. 27 March 1814 - Millwright, Hermitage							
Drawing or Photograph					Inscription					

In
Memory of
SOPHIA the Affectionate *Wife* of
JOHN HARRIS WRIGHT
and *Daughter* of WILLIAM
and ANN DAY
who died the 14th of August 1845
Aged 32 Years
*After a Long and painful
Illness which She endured
with peace and resignation*

In
Memory of
SOPHIA the Affectionate *Wife* of
JOHN HARRIS WRIGHT
and *Daughter* of WILLIAM
and ANN DAY
who died the 14th of August 1845
Aged 32 Years
*After a Long and painful
Illness which She endured
with peace and resignation*

Footstone NEB 234

Grave Memorial Recording Form: St. John the Baptist, Westbourne, W. Sussex

1	National Grid Reference	755 073	Date	1	5	0	8	0	0
2	Name of recorder(s)	June Marshall							
3	Record No. of memorial (plus components i,ii,iii etc.)	NEB		2	4	4			
4	No. of components or inscribed faces (record on reverse if possible)								
5	Type of memorial: 1 = flat 2 = head 3 = tomb 4 = foot 5 = tablet 6 = other	2							
6	Material and geology	Limestone							
7	Stone mason or undertaker	Not known							
8	Which surfaces inscribed (facing N, S, E or W)	W							
9	No. of people commemorated	2							
10	Condition of monument: 1=sound 2=displaced 3=leaning 4=collapsed 5=damaged	1							
11	Technique of inscription: 1 = Incised 2 = carved in relief 3 = cast in relief 4 = lead letters 5 = painted - remains of black paint	5 1							
12	Condition of inscription 1 = very good 2 = clear 3 = worn but decipherable 4 = partly legible 5 = illegible	1							
13	Dimensions (metric)	height	1	3	6	0			
		width		7	4	0			
		Thickness (or length in case of tombs)			7	0			
14	Date of memorial	1847†	Register	Ann Day, Hermitage, bu. 19 May 1832, a 56					
	William Day, Hermitage, bu. 11 July 1847 a. 75								
Drawing or Photograph					Inscription				

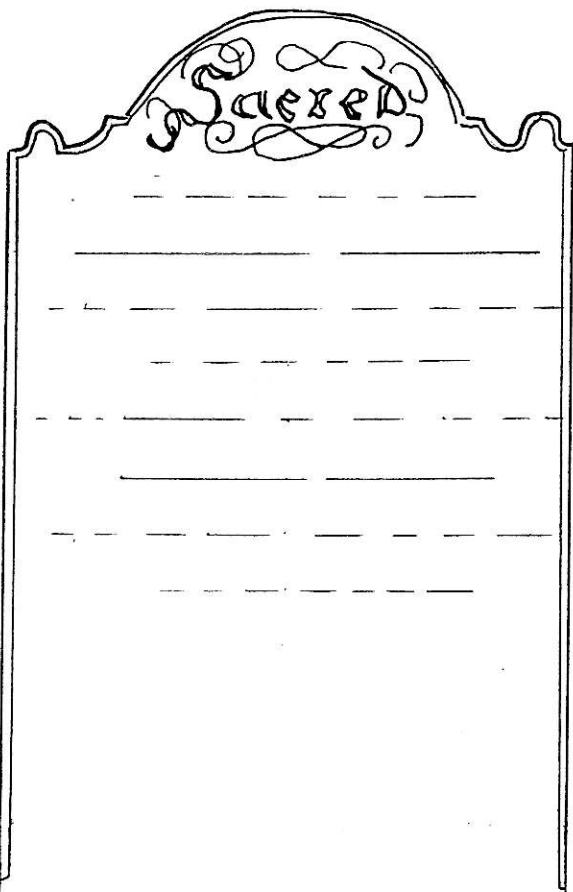

Sacred
 to the Memory of
WILLIAM DAY
 who died the 8th of July 1847
 Aged 75 Years
 Also ANN Wife of the above
WILLIAM DAY
 who died the 13th of May 1832
 Aged 55 Years

Footstone is no. NEB 232

Grave Memorial Recording Form: St. John the Baptist, Westbourne, W. Sussex

1	National Grid Reference	755 073	Date	1	5	8	0	0
2	Name of recorder(s)	SHIRLEY HARVEY-WHITING.						
3	Record No. of memorial (plus components i,ii,iii etc.)	N	E	B	2	4	5	
4	No. of components or inscribed faces (record on reverse if possible)							
5	Type of memorial: 1 = flat 2 = head 3 = tomb 4 = foot 5 = tablet 6 = other	1						
6	Material and geology	STONE; LIMESTONE						
7	Stone mason or undertaker	NONE FOUND						
8	Which surfaces inscribed (facing N, S, E or W)	W						
9	No. of people commemorated	1						
10	Condition of monument: 1=sound 2=displaced 3=leaning 4=collapsed 5=damaged	1						
11	Technique of inscription: 1 = incised 2 = carved in relief 3 = cast in relief 4 = lead letters 5 = painted	1						
12	Condition of inscription 1 = very good 2 = clear 3 = worn but decipherable 4 = partly legible 5 = illegible	2						
13	Dimensions (metric)	height	1	1	5	0		
		width		6	2	0		
		Thickness (or length in case of tombs)			6	5		
14	Date of memorial	1842.	Register Ann Day, Hermitage, bu. 8 Aug. 1842					
		Ellen Wright, Hermitage, bu. 15 Oct. 1842, aged 1.						
		aged 38						
Drawing or Photograph			Inscription					

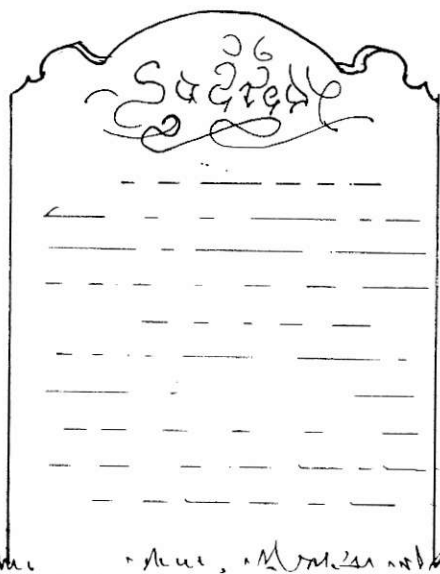

Sacred

to the Memory of
ANN Eldest Daughter of
WILLIAM and ANN DAY
who Died 2nd of August 1842
Aged 38 Years.
Also ELLEN Daughter of
JOHN and SOPHIA WRIGHT
and niece of the above
who Died 10th of October 1842
Aged 1 Year and 4 Months